

360°

SISTEMI
INNOVATIVI

BAGNO

CERAMICA
ALTHEA

VOL. 4

INDICE

INDEX



WC E BIDET

COVER RIMLESS

P. 30

COVER XL

P. 46

FUJI RIMLESS

P. 50

TAK RIMLESS

P. 56

SOLI RIMLESS

P. 60

SEVEN RIMLESS

P. 72

COVER PLUS+TON

P. 84



LAVABI

LAVABI D'ARREDO

P. 92



PIATTI DOCCIA

PIATTO DOCCIA UP - JO' 3 cm

P. 126

PIATTO DOCCIA ITO 5,5 cm

P. 144

PIATTO DOCCIA LONDON cm 2,5

P. 154



Welcome to

CERAMICA ALTHEA



Estensione
Extension of factory

40.000 m²

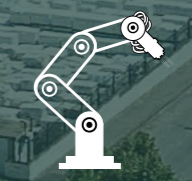

Tecnologia avanzata
Advanced technology



Latitude: 42.326474
Longitude: 12.446566



MADE IN ITALY

COME NASCE LA **CERAMICA** DI **ALTHEA**

L'utilizzo di materie di prima scelta e l'efficienza tecnologica rendono la produzione di sanitari, lavabi e piatti doccia **Althea** la migliore offerta di qualità oggi presente sul mercato.

The use of first choice materials and the technological efficiency make the production of **Althea's** sanitary ware, washbasins and shower trays the best offer and quality present on the market today.



Miscelando polveri minerali di altissima qualità ed acqua si ottiene un impasto denso, il *Fine Fire Clay*.

Mixing high quality mineral powders and water you obtain a dense mixture, the *Fine Fire Clay*.

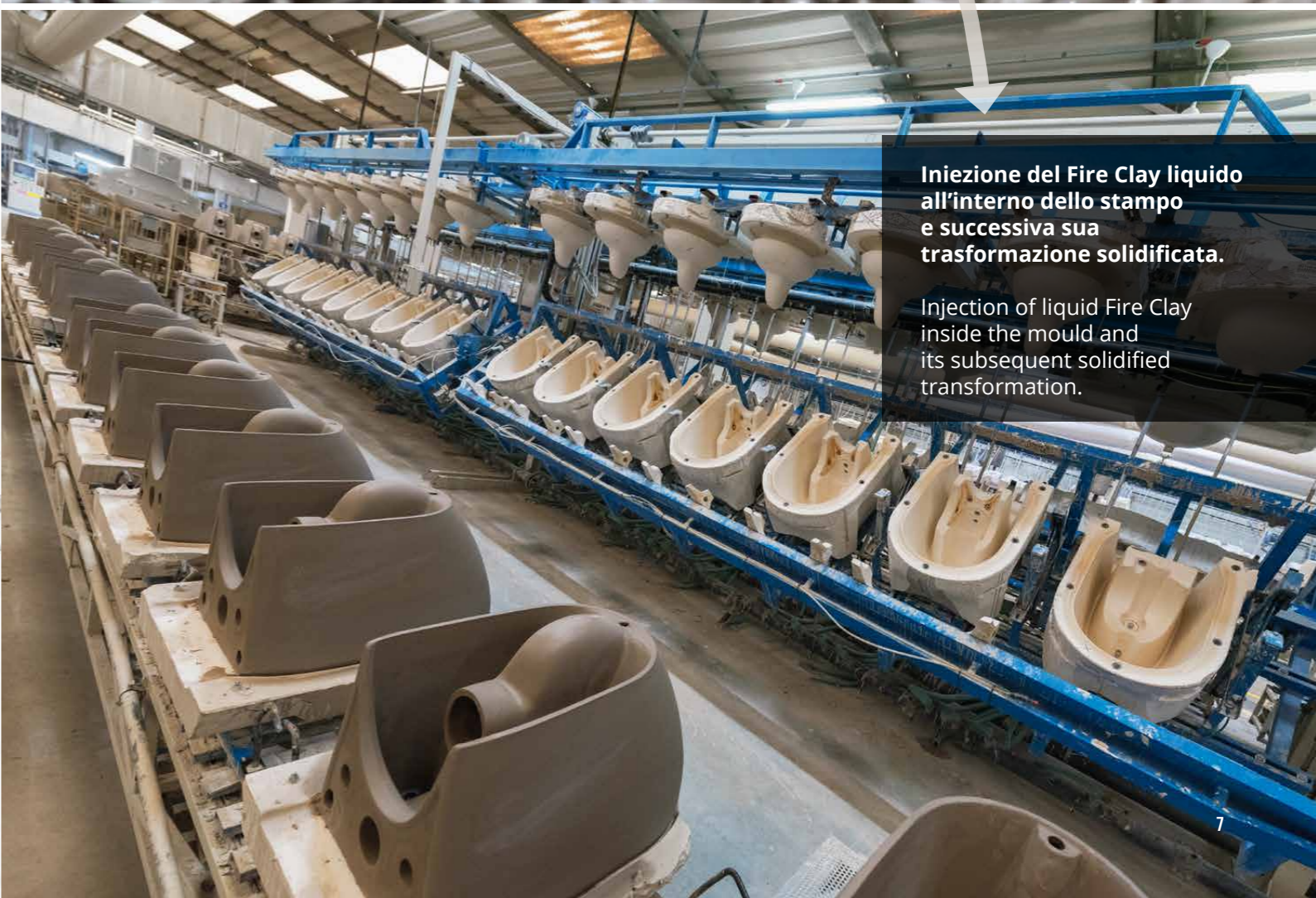

Iniezione del Fire Clay liquido all'interno dello stampo e successiva sua trasformazione solidificata.

Injection of liquid Fire Clay inside the mould and its subsequent solidified transformation.

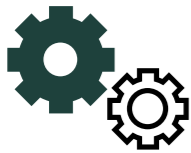

PRODUZIONE, INNOVAZIONE

Valore aggiunto dell'intero ciclo produttivo è l'utilizzo di macchinari di ultima generazione. Sotto l'attenta supervisione del personale tecnico specializzato, ogni fase produttiva è sottoposta a rigorosi controlli. L'attenzione dedicata allo studio dei prodotti consente ad **Althea** di immettere sul mercato articoli contraddistinti da un elevato standard qualitativo, così da soddisfare il gusto e le necessità dei propri clienti.

The added value of the entire production cycle is the use of the latest generation machinery. Under the careful supervision of skilled technical personnel, each production stage undergoes strict controls. The attention dedicated to the study of products enables **Althea** to introduce to the market products distinguished by high quality standards, so as to satisfy the tastes and needs of its customers.



1.250°

L'altissima temperatura per la fusione (1.250°) nei forni a tunnel di ultima generazione fissa il colore brillante ed uniforme dei prodotti di alta qualità **Althea**.

The very high fusion temperature (1.250°) in the latest generation tunnel kilns fixes the bright and uniform colour of the **Althea** high quality products.

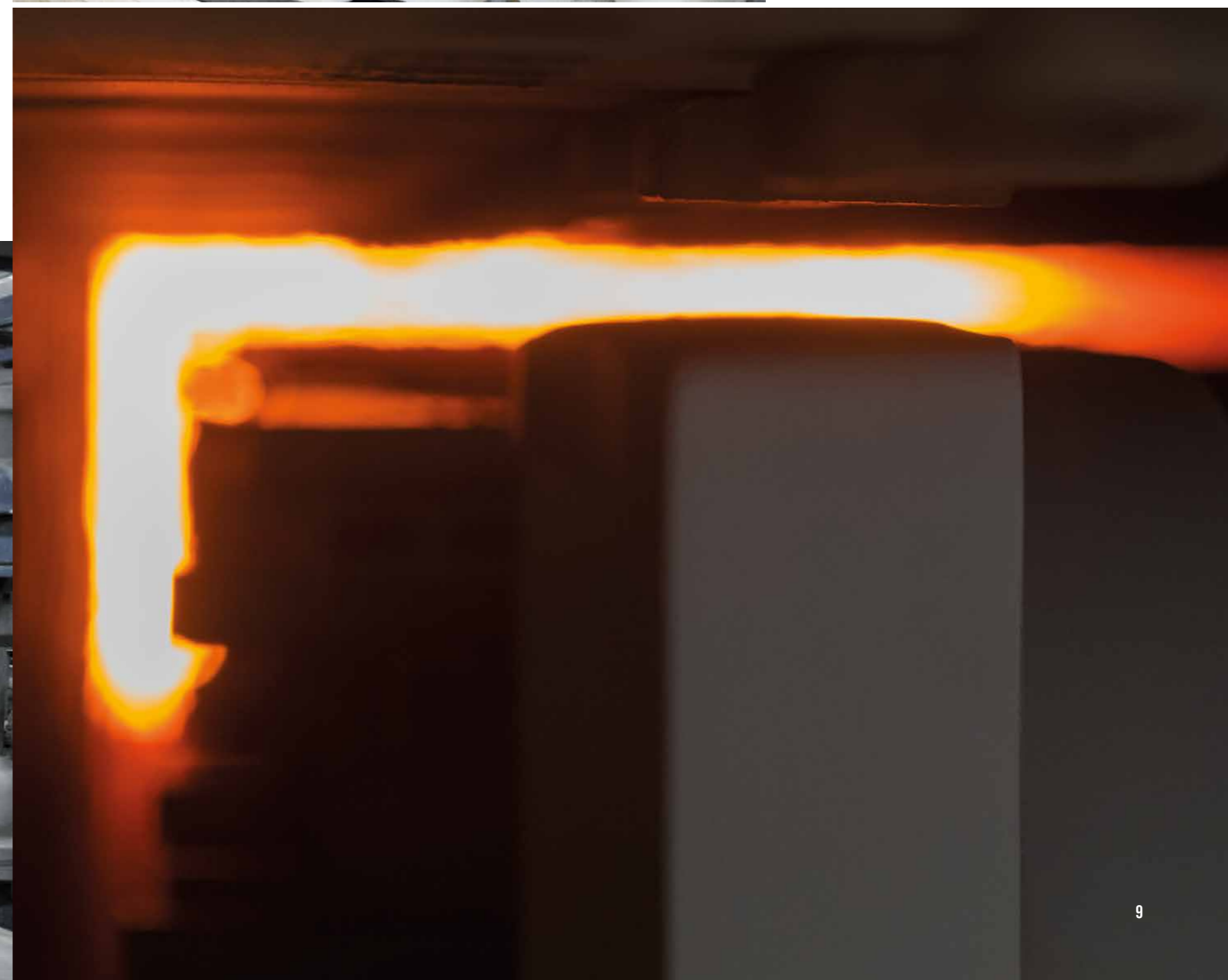

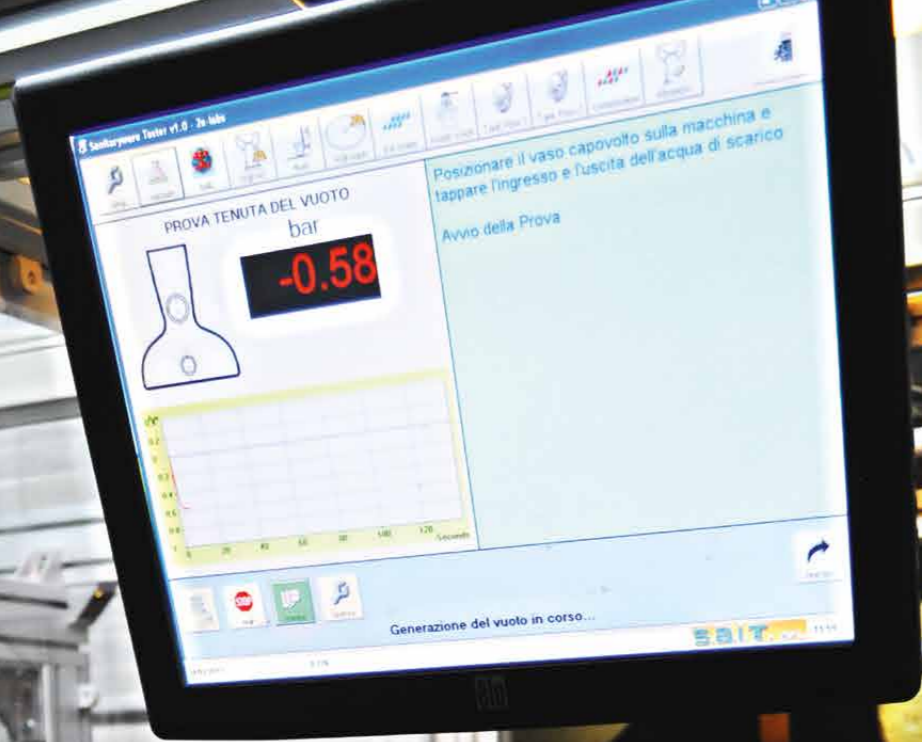

TEST AREA

L'alta qualità dei sanitari **Althea** è garantita da scrupolosi e costanti controlli secondo le normative vigenti.

The high quality of the **Althea** sanitary ware is guaranteed by scrupulous and constant checks according to the regulations in force.



3 L

Prove di evacuazione con 3 L di scarico
Flush test with 3 L



Test di carico statico con 400 Kg
su sanitari sospesi
Static load test with 400 kg
on wall hung sanitary ware

400 Kg

120"

Test di tenuta al vuoto per 120
secondi a - 0,6 Bar
Vacuum leak test for 120
seconds at - 0.6 Bar

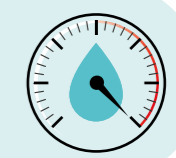

Test di scarico di 50 biglie di plastica
con 3,5 L di acqua
Flush test with 50 plastic balls
with 3.5 L of water

50
BIGLIE

UNI EN 997 REGULATION



RISPARMIO IDRICO 3 L

WATER SAVING 3 L



L'attenzione al risparmio idrico è oggetto di studio a partire dalla fase di progettazione. Tutte le tipologie di wc sono ottimizzate per un'evacuazione con **3 litri d'acqua**. Nel pieno rispetto delle direttive comunitarie, i prodotti **Althea** sono marcati **CE** a indicare che il prodotto è conforme a tutte le disposizioni comunitarie. Ogni prodotto viene sottoposto a rigorosi controlli da parte del personale qualificato. Nel laboratorio tecnico, provvisto di macchinari di ultima generazione, vengono effettuati test di controllo della qualità, della funzionalità e delle prestazioni dei prodotti, confermandone l'idoneità all'immissione sul mercato.

The attention to water saving has been studied from the planning stage. All the WC categories are optimized for evacuation with **3 litres of water**. In full respect of the European directives, the **Althea** products are marked **CE**, to indicate that the items are in compliance with all European regulations. Each article is subject to meticulous controls by skilled personnel. In the technical laboratory, equipped with the latest generation machinery, are carried out quality functionality and performance tests on all items, confirming the suitability for the introduction onto the market.

CERAMICA
ALTHEA



La forte attenzione per il design contraddistingue da sempre la progettazione **Althea**. Questo valore aggiunto è attestato da numerosi riconoscimenti ricevuti quali il **DESIGN PLUS**, il **GOOD DESIGN** e le nomine al **DESIGNPREIS** per diverse collezioni di prodotti, oltre che da prestigiose partecipazioni tra le quali l'esposizione alla Triennale di Milano "**The New Italian Design**" e alla manifestazione **RomaD+ "Design for Made in Italy"**. Nel 2015, lo straordinario materiale *Plus+ton*, brevetto registrato, ha conseguito a Londra il **D Award** nella categoria *Innovation in materials*.

The great attention to design has always distinguished the **Althea** projects. This added value is supported by numerous awards such as the **DESIGN PLUS**, the **GOOD DESIGN** and the nominations to **DESIGNPREIS** for different ranges of products, besides prestigious participations including the exposition at "**The New Italian Design**" at the Triennale di Milano and at the **RomaD+** event "**Design for Made in Italy**". In 2015, the extraordinary *Plus+ton* material, registered patent, has achieved in London the **D Award** in the *Innovation in materials* category.



DESIGN PLUS
2007



Week **RomaD+**
design più EXPODESIGN





PRONTA CONSEGNA
24 / 48 H

plus+ton®

Unico e non imitabile

Da un'unica fusione ad altissime temperature di **1.250°**, prende vita un materiale ceramico, qualificato come **totalmente riciclabile** e quindi **100% ecologico**, derivato da un ciclo produttivo privo di emissioni inquinanti in atmosfera.

plus+ton è una superficie ceramica completamente **anti-graffio, anti-macchia, anti-scivolo, anti-batterica** e sostituisce facilmente quei prodotti realizzati con resine, solventi e catalizzatori, materiali altamente inquinanti e non riciclabili.

plus+ton utilizza esclusivamente **materie prime naturali** di altissima qualità con la sola aggiunta di **acqua e fuoco**.

INDUSTRIAL INVENTION
PATENT No. AN2014A000135

From one single fusion at very high temperatures of **1.250°**, comes to life a ceramic material qualified as **entirely recyclable** and therefore **100% eco-friendly**, derived from a productive cycle with no pollutant emissions into the atmosphere.

plus+ton is a ceramic surface completely **scratch-proof, stain-proof, slip-proof, as well as bacterial resistant** and can easily replace those products manufactured using resins, solvents and catalysts; materials that are highly pollutant and non-recyclable.

plus+ton uses only **natural raw materials** of the highest quality by just adding **water and fire**.



anti-graffio
scratch-proof



anti-macchia
stain-proof



anti-batterico
bacterial resistant



stabilità cromatica
chromatic stability



anti-scivolo
slip-proof





ANTI - GRAFFIO SCRATCH-PROOF

Il test di resistenza all'abrasione e al graffio ha evidenziato una perfetta tenuta della superficie **plus+toni**, superando i valori della norma di riferimento **UNI 4543/2**.

The test against abrasion and scratching has shown the perfect resistance properties of the **plus+toni** surface, exceeding the values of the standard of reference **UNI 4543/2**.

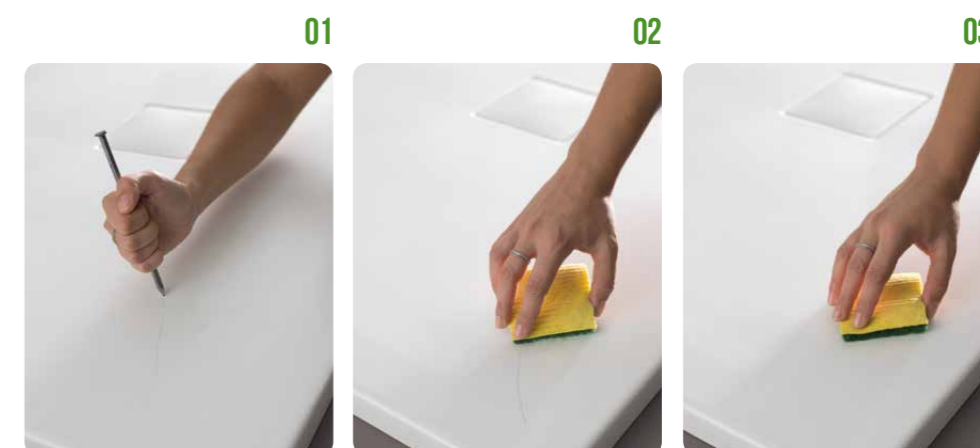







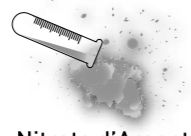

MACCHIE ESTREME EXTREME STAINS

**Rimozione rapida delle
sostanze macchianti
con acqua.**

Quick removal of
staining substances
with water.

| Sostanze acide o altamente macchianti Acid or highly staining substances | Tempo di posa Standing time | Risultato prova UNI 4543/2 Result of the UNI 4543/2 test |
|---|--------------------------------|---|
|  Acido Cloridrico Hydrochloric Acid | 16 H hrs. | Nessuna perdita di brillantezza o macchie permanenti No loss in brilliancy and no permanent stains. |
|  Nitrato d'Argento Silver Nitrate | 72 H hrs. | Nessuna perdita di brillantezza o macchie permanenti No loss in brilliancy and no permanent stains. |
|  Tintura di Iodio Iodine dye | 72 H hrs. | Nessuna perdita di brillantezza o macchie permanenti No loss in brilliancy and no permanent stains. |
|  Blu di Metilene Methylene Blue | 72 H hrs. | Nessuna perdita di brillantezza o macchie permanenti No loss in brilliancy and no permanent stains. |
|  Permanganato di Potassio Potassium permanganate | 72 H hrs. | Nessuna perdita di brillantezza o macchie permanenti No loss in brilliancy and no permanent stains. |
|  Inchiostro Ink | 72 H hrs. | Nessuna perdita di brillantezza o macchie permanenti No loss in brilliancy and no permanent stains. |
|  Tinta per capelli Hair Dye | 72 H hrs. | Nessuna perdita di brillantezza o macchie permanenti No loss in brilliancy and no permanent stains. |
|  Smalto per unghie Nail Polish | 72 H hrs. | Nessuna perdita di brillantezza o macchie permanenti No loss in brilliancy and no permanent stains. |



ANTI - MACCHIA E ANTI - CALCARE STAIN-PROOF AND LIMESCALE-PROOF

plus+con è privo di porosità e qualsiasi agente macchiante si deposita sulla superficie senza penetrare negli strati interni della ceramica, permettendone quindi la rimozione con solo acqua. Non è necessario nessun trattamento, plus+con è **antimacchia certificato**, secondo la normativa **UNI4543/2**.

plus+con is non porous and any staining agent can deposit on the surface without penetrating the inner layers of the ceramic, therefore allowing its removal simply with water. No treatment is necessary, plus+con is **certified stain-proof** according to the **UNI4543/2** regulation.

01



02



03





ANTI - SCIVOLO

SLIP - PROOF

plus **boni** garantisce una **superficie antiscivolo** nella sua propria unica fusione, ottenuta ad altissime temperature di 1.250° e per questo è indelebile e garantito a vita.

plus **boni** guarantees a **slip-proof surface** thanks to its own single fusion, achieved at very high temperatures of 1.250° and for this reason is permanent and guaranteed a lifetime.

Pendulum BS 7976:2002 *English certification*
Result = Excellent



Una delle innumerevoli applicazioni di questo straordinario materiale ceramico, uno spazio ideato per accogliere i nostri visitatori:

One of the countless applications of this extraordinary ceramic material, a space designed to welcome our guests:

plus+ton®

Lounge

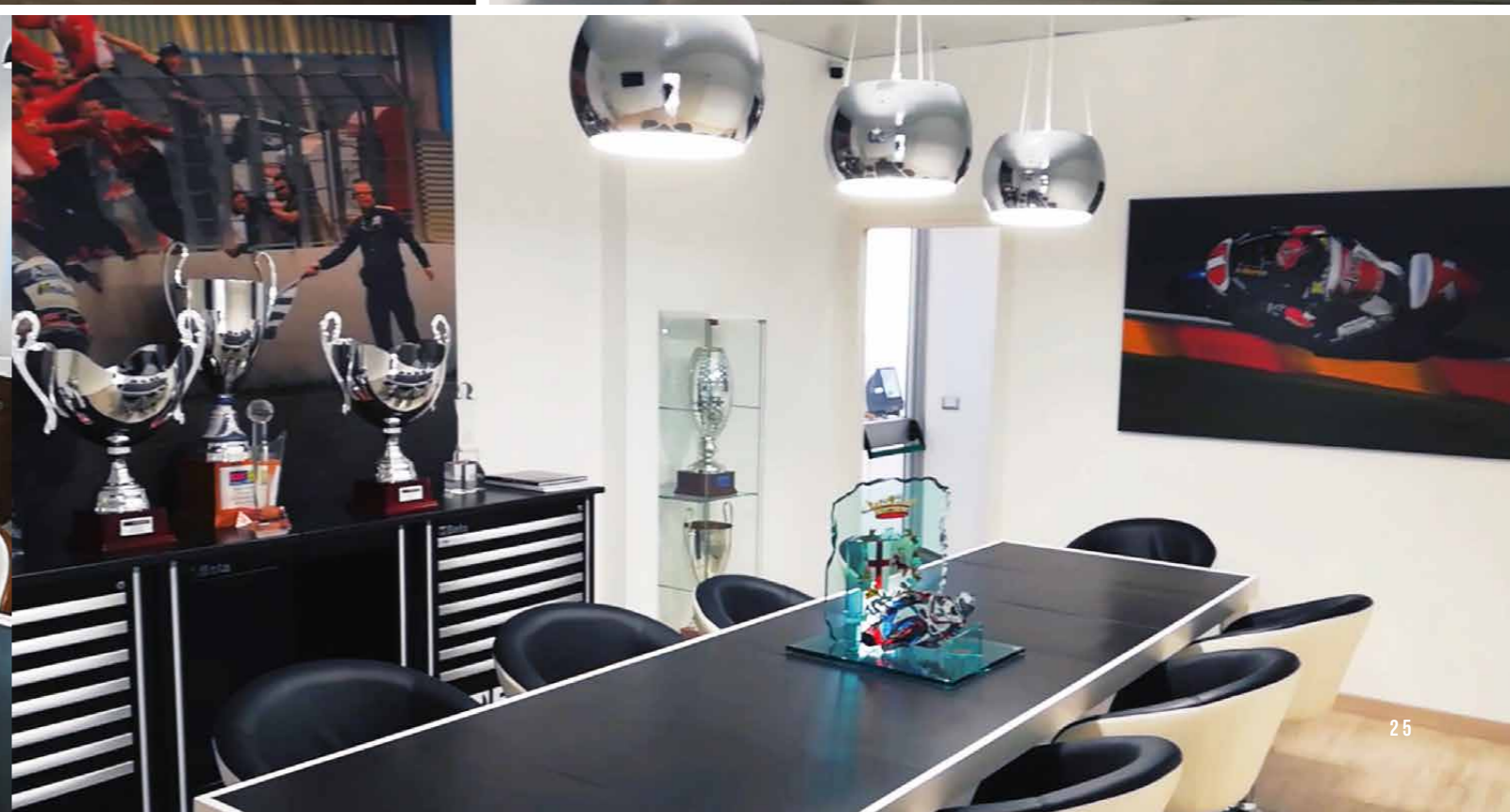



plus+ton®
WORLDWIDE

Un marchio che fa il giro del mondo

Althea Ceramica è anche proprietaria dello storico Team Althea Racing che ha partecipato negli anni sia in MOTO GP (con Honda ufficiale 125 cc ed il campione del mondo Kazuto Sakata fino al '99) che in World Superbike Championship in abbinamento con Ducati, BMW e Honda.

Nel 2011 con la storica casa di Borgo Panigale, Althea conquista un prestigioso record di quattro titoli mondiali in un solo anno:

1° Campionato SBK 2011 - Rider Carlos Checa

1° Campionato marche SBK 2011 - DUCATI

1° Campionato STK 1000 2011 - Rider Davide Giugliano

1° Campionato marche STK 1000 2011 - DUCATI

Nel 2016 il team Althea con il pilota Raffaele De Rosa, in sella alla BMW S 1000 RR, conquista il titolo mondiale Superstock.

plus+ton è oggi uno dei partner principali di Althea Racing World Superbike; diffondendo il proprio marchio nel mondo, attraverso i media ed i TV coverage, plus+ton si distingue per le sue eccezionali caratteristiche nel Racing dell'alta ingegneria e tecnologia applicata.

E' per questo che plus+ton è la nuova frontiera della ceramica ed allo stesso tempo un'alternativa al mercato tradizionale finora conosciuto.

plus+ton viaggia veloce da "CAMPIONE DEL MONDO".

A brand known throughout the world

Althea Ceramica also owns the historic Althea Racing Team that has participated over the years both in the MOTO GP (with the official Honda 125 cc and the world champion Kazuto Sakata until '99) and in the World Superbike Championship in combination with Ducati, BMW and Honda.

With the historic Borgo Panigale factory, Althea wins in 2011 a prestigious record of four world titles in one single year:

1st - 2011 SBK Championship - Rider Carlos Checa

1st - 2011 SBK brands Championship - DUCATI

1st - 2011 STK 1000 Championship - Rider Davide Giugliano

1st place - 2011 STK 1000 brands Championship - DUCATI

In 2016 the Althea team with the rider Raffaele De Rosa wins the Superstock world title on the BMW S 1000 RR.

plus+ton is today one of the main partners of the World Superbike Althea Racing spreading worldwide its own brand through media and TV coverage; plus+ton stands out for its exceptional characteristics in high Racing engineering and applied technology. This is why plus+ton is the new frontier of ceramics and at the same time an alternative to the traditional market known so far.

plus+ton moves as fast as a "WORLD CHAMPION".





WC E BIDET

FILOMURO / SOSPESI

Filomuro o sospesi, linee stondate, profili minimali e tutta l'innovazione tecnica del sistema di scarico

RIMLESS - WATER SAVING.

La vasta scelta di prodotti **Althea** hanno in comune una caratteristica:

la **QUALITÀ GARANTITA.**

SISTEMA DI SCARICO RIMLESS
RIMLESS SYSTEM

RISPARMIO IDRICO 3 L
WATER SAVING 3 L

COVER RIMLESS

VERSIONI DISPONIBILI / AVAILABLE MODELS
BIDET SOSPESO / BIDET FILOMURO
BIDET TRASLATO / BIDET H. 50
WALL HUNG BIDET / BACK TO WALL BIDET
ADJUSTABLE BIDET / H. 50 BIDET

COPRIWC SOFT-CLOSE
CON SGANCIO RAPIDO
QUICK RELEASE
SOFT-CLOSE SEAT COVER

VERSIONI DISPONIBILI / AVAILABLE MODELS
WC SOSPESO / WC FILOMURO / WC MONOBLOCCO
WC TRASLATO / WC H. 50
WALL HUNG WC / BACK TO WALL WC / CLOSE-COUPLED WC
ADJUSTABLE WC / H. 50 WC



COVER
RIMLESS

SOSPESI





FINITURE DISPONIBILI:



BIANCO
LUCIDO



BIANCO
MATT

COVER RIMLESS

Wc e bidet sospesi

COVER

RIMLESS

FILOMURO

COVER RIMLESS

Wc e bidet filomuro

cm 52X36

FINITURE DISPONIBILI:



BIANCO
LUCIDO



BIANCO
MATT

COVER RIMLESS

CM 52X36



Per i WC rimless si consiglia di ridurre la pressione dell'acqua e la quantità dei litri di scarico come indicato
For rimless WC pans it is recommended to reduce the water pressure and the flush volume (litres of water) as indicated

COVER RIMLESS

WC filo-muro scarico pavimento/parete
BTW WC floor-wall trap

BIANCO LUCIDO COD. **CV012**
BIANCO MATT COD. **CV012#BM**



| COD. | KG |
|----------|------|
| CV012 | 24 |
| CV012#BM | 24 |
| CTWC | 0,35 |
| RIDFLU | 0,02 |

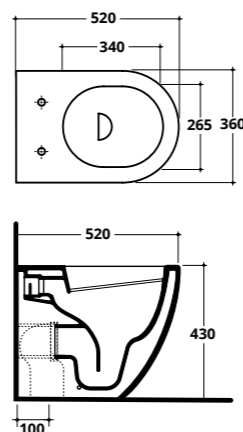

Curva tecnica
Pipe fitting

COD. **CTWC**



Riduttore di flusso
WC flow reducer

COD. **RIDFLU**

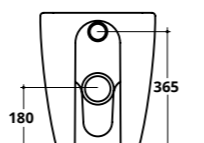

COVER RIMLESS

Bidet monoforo con troppopieno
One tap hole BTW bidet with overflow

BIANCO LUCIDO COD. **CV003**
BIANCO MATT COD. **CV003#BM**



| COD. | KG |
|----------|----|
| CV003 | 24 |
| CV003#BM | 24 |

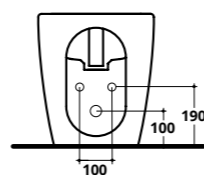
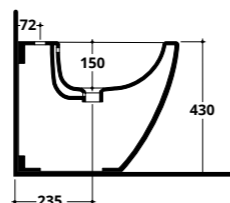
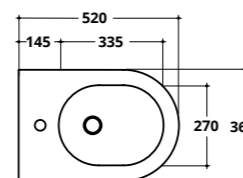

COVER RIMLESS - CM 58X36 H. 81
WC monoblocco
Close-coupled WC

COD. **CV014**

Cassetta monoblocco
Close-coupled cistern

COD. **CV015**

Meccanismo
Mechanism
COD. **30090**



| COD. | KG |
|-------|------|
| CV014 | 34 |
| CV015 | 10 |
| 30090 | 0,7 |
| CTWC | 0,35 |



Curva tecnica
Pipe fitting

COD. **CTWC**

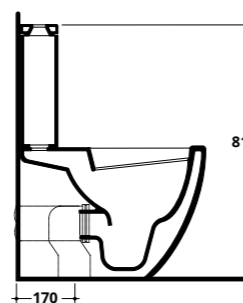
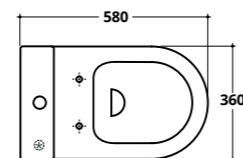

✱ Entrata acqua
Inlet water

Carico acqua
cassetta
Cistern inlet
water

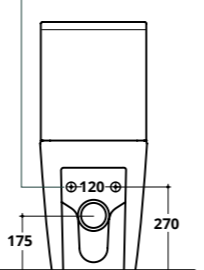

COVER RIMLESS



IMBALLO COMPLETO
VERSIONE FILO MURO

GLI ACCESSORI PRESENTI NELLA SCATOLA
SONO A PAGAMENTO
THE ACCESSORIES CONTAINED IN THE BOX HAVE TO
BE PAID FOR SEPARATELY



COVER RIMLESS - COPRI WC

Copri wc slim soft-close con sgancio rapido
Quick release slim soft-close seat cover

BIANCO LUCIDO COD. **CV007S**

BIANCO MATT COD. **CV007S#BM**



Fissaggi in plastica per WC e bidet
Plastic brackets for BTW WC - bidet

COD. **FIX01**

COVER RIMLESS

CM 52X36

COVER RIMLESS
WC sospeso
Wall hung WC

BIANCO LUCIDO COD. **CV013**
BIANCO MATT COD. **CV013#BM**



| COD. | KG |
|----------|------|
| CV013 | 26 |
| CV013#BM | 26 |
| RIDFLU | 0,02 |



Per i WC rimless si consiglia di ridurre la pressione dell'acqua e la quantità dei litri di scarico come indicato
For rimless WC pans it is recommended to reduce the water pressure and the flush volume (litres of water) as indicated

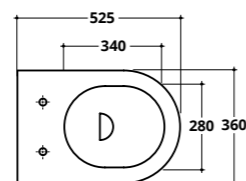

Riduttore di flusso
WC flow reducer
COD. **RIDFLU**

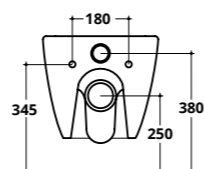
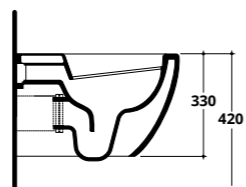

COVER RIMLESS

Bidet sospeso monoforo con troppopieno
Wall hung one tap hole bidet with overflow

BIANCO LUCIDO COD. **CV004**
BIANCO MATT COD. **CV004#BM**



| COD. | KG |
|----------|----|
| CV004 | 22 |
| CV004#BM | 22 |

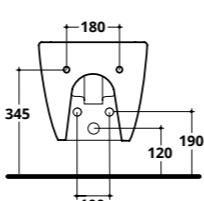
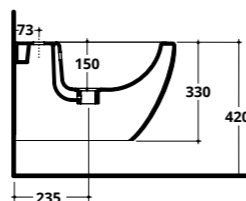
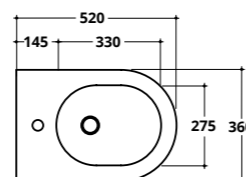

Staffa di fissaggio per WC e bidet sospesi
Bracket for wall hung WC - bidet

COD. **FIX03**



Piletta di scarico click-clack con tappo in ceramica universale
Click-clack waste mechanism with universal ceramic cover

BIANCO LUCIDO COD. **CCNEW**
BIANCO MATT COD. **PCCNEW**



Espositore metallico per WC e bidet sospesi
Metal display stand for wall hung wc and bidet

COD. **MINIEXPO**



COVER RIMLESS



IMBALLO COMPLETO
VERSIONE SOSPESI



GLI ACCESSORI PRESENTI NELLA SCATOLA SONO A PAGAMENTO
THE ACCESSORIES CONTAINED IN THE BOX HAVE TO BE PAID FOR SEPARATELY



COVER RIMLESS - COPRI WC
Copri wc slim soft-close con sgancio rapido
Quick release slim soft-close seat cover

BIANCO LUCIDO COD. **CV007S**
BIANCO MATT COD. **CV007S#BM**



Fissaggio rapido per WC e bidet sospesi
Quick fixing kit for wall hung WC - bidet

COD. **40951**

COVER RIMLESS TRASLATI H.43

CM 56X36



COVER RIMLESS - TRASLATO CM 56X36 H. 43

WC filo-muro **TRASLATO** scarico pavimento/parete
BTW WC floor-wall trap
ADJUSTABLE INSTALLATION

COD. **CV010**



| COD. | KG |
|--------|------|
| CV010 | 32,5 |
| CTWCTR | 0,5 |
| RACEC | 0,1 |
| RIDFLU | 0,02 |

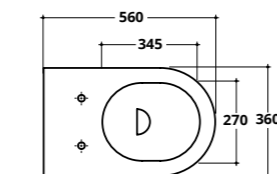

MIN 6 cm / MAX 26 cm

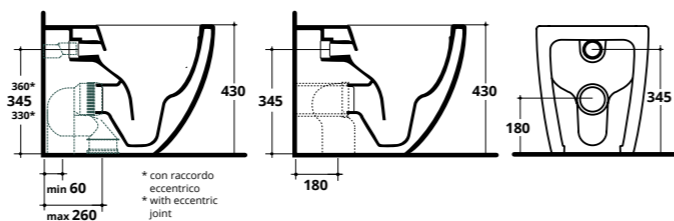

COVER RIMLESS TRASLATI H.50

CM 56X36



COVER RIMLESS - TRASLATO CM 56X36 H. 50

WC filo-muro **TRASLATO** scarico pavimento/parete
BTW WC floor-wall trap
ADJUSTABLE INSTALLATION

COD. **CV008**



| COD. | KG |
|--------|------|
| CV008 | 34,5 |
| CTWCTR | 0,5 |
| RACEC | 0,1 |
| RIDFLU | 0,02 |



MIN 6 cm / MAX 27 cm

COVER RIMLESS - TRASLATO CM 56X36 H. 43

Bidet **TRASLATO** monoforo con troppopieno
One tap hole BTW bidet with overflow
ADJUSTABLE INSTALLATION

COD. **CV011**



| COD. | KG |
|-------|------|
| CV011 | 27,5 |

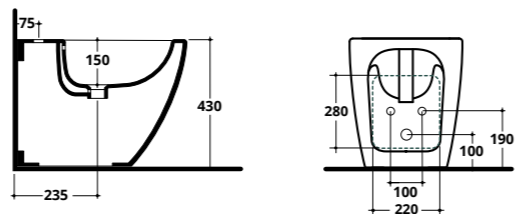
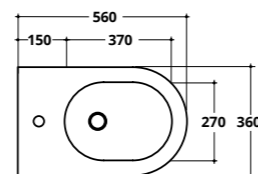

COVER RIMLESS - TRASLATO CM 56X36 H. 50

Bidet **TRASLATO** monoforo con troppopieno
One tap hole BTW bidet with overflow
ADJUSTABLE INSTALLATION

COD. **CV009**



| COD. | KG |
|-------|------|
| CV009 | 29,5 |

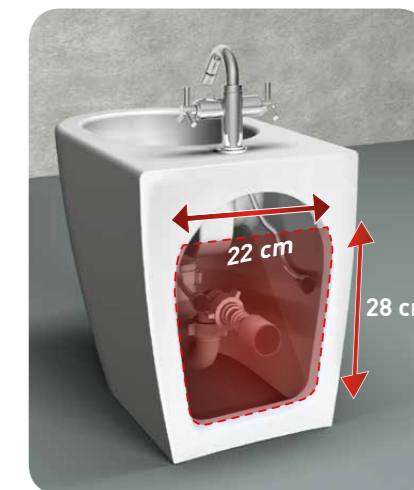

Fissaggi in plastica per WC e bidet
Plastic brackets for BTW WC - bidet
COD. **FIX01**



COD. **CTWCTR**



COD. **RACEC**



Riduttore di flusso
WC flow reducer
COD. **RIDFLU**

Per i WC rimless si consiglia di ridurre la pressione dell'acqua e la quantità dei litri di scarico come indicato
For rimless WC pans it is recommended to reduce the water pressure and the flush volume (litres of water) as indicated

COVER RIMLESS - COPRI WC

Copri wc slim soft-close con sgancio rapido
Quick release slim soft-close seat cover

COD. **CV007S**



Piletta di scarico click-clack con tappo in ceramica universale
Click-clack waste mechanism with universal ceramic cover

GLOSS WHITE COD. **CCNEW**



Fissaggi in plastica per WC e bidet
Plastic brackets for BTW WC - bidet
COD. **FIX01**



COD. **CTWCTR**



COD. **RACEC**



Riduttore di flusso
WC flow reducer
COD. **RIDFLU**

Per i WC rimless si consiglia di ridurre la pressione dell'acqua e la quantità dei litri di scarico come indicato
For rimless WC pans it is recommended to reduce the water pressure and the flush volume (litres of water) as indicated

COVER RIMLESS - COPRI WC

Copri wc slim soft-close con sgancio rapido
Quick release slim soft-close seat cover

COD. **CV007S**



Piletta di scarico click-clack con tappo in ceramica universale
Click-clack waste mechanism with universal ceramic cover

GLOSS WHITE COD. **CCNEW**



PERCHÈ SCEGLIERE IL WC COVER RIMLESS TRASLATO?

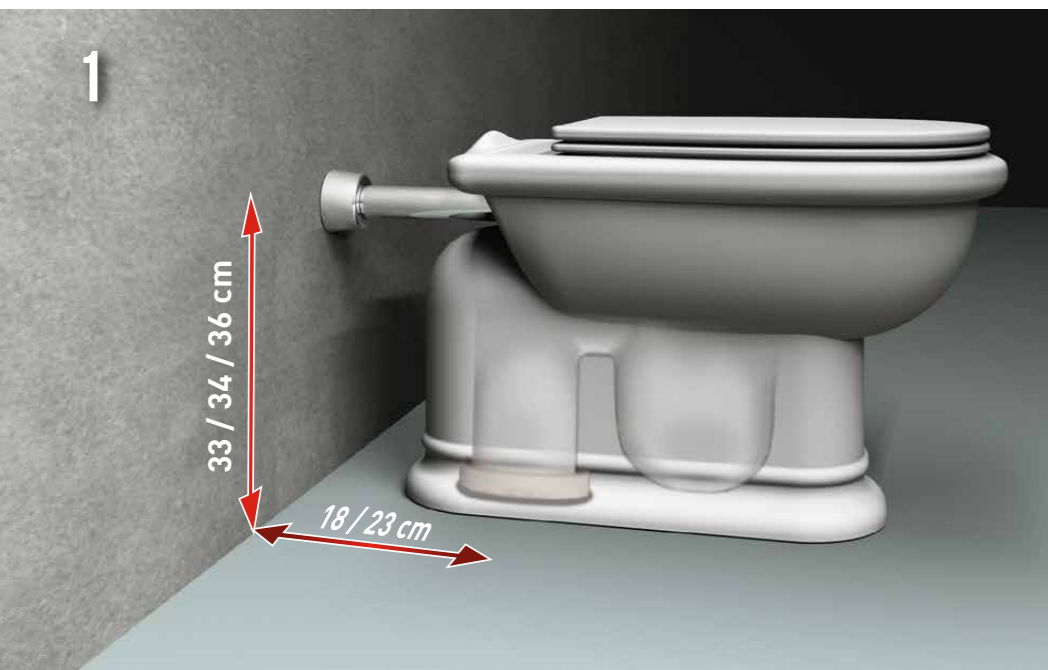

Il **WC tradizionale** ha lo **scarico** posizionato mediamente **tra i 18 e i 23 cm** dalla parete e l'entrata dell'acqua ha altezze variabili.

The **traditional WC** has the drain outlet positioned on average **between 18 and 23 cm** from the wall and the water inlet has variable heights.

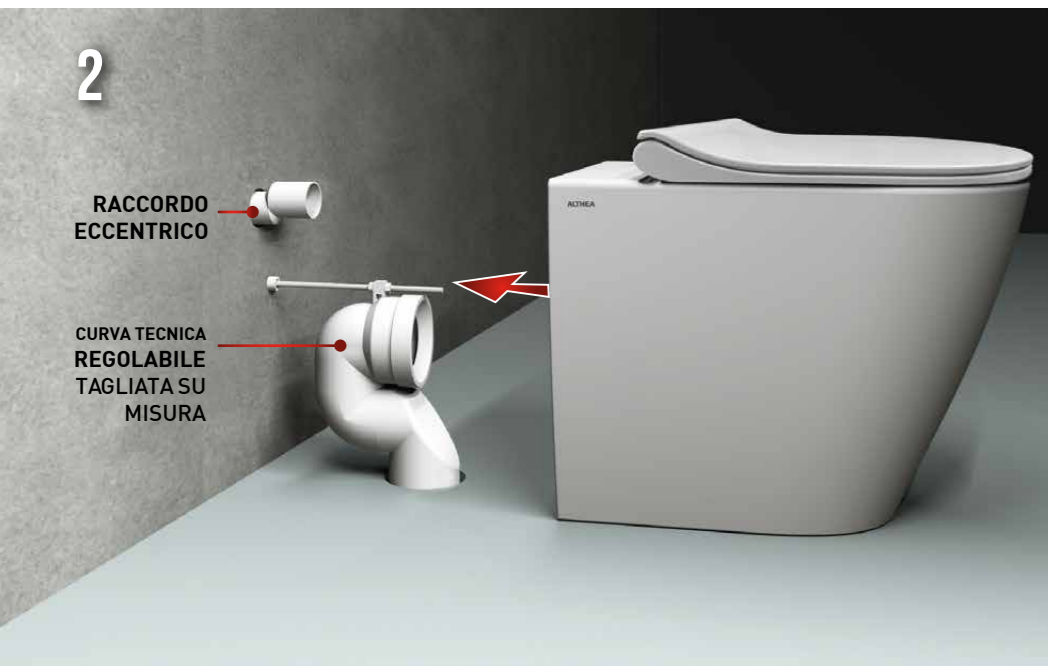

La particolare conformazione del **WC COVER RIMLESS TRASLATO** consentirà una perfetta installazione sul vecchio impianto.

The particular conformation of the **COVER RIMLESS WC with ADJUSTABLE water inlet/outlet** allows perfect installation on the old system.



WC COVER RIMLESS TRASLATO filo-muro con una comoda profondità di **56 cm** e altezza entrata acqua regolabile tramite raccordo eccentrico.

COVER RIMLESS BTW WC with ADJUSTABLE water inlet/outlet with a comfortable depth of **56 cm** and adjustable water inlet height by means of an eccentric joint.

PERCHÈ SCEGLIERE IL BIDET COVER RIMLESS TRASLATO?



Esempio di **bidet tradizionale**. Non sono necessari **onerosi lavori di muratura** per sostituirlo. Le utenze acqua calda / fredda hanno mediamente un **interasse di 18 / 20 cm**.

Example of **traditional bidet**. No **expensive masonry work** is required to replace it. The hot / cold water utilities have an average **centre-to-centre distance of 18 / 20 cm**.



Il **bidet COVER TRASLATO** si adatta perfettamente al vecchio impianto grazie alla sua particolare conformazione.

The **ADJUSTABLE COVER bidet** adapts perfectly to the old installation system thanks to its particular conformation.

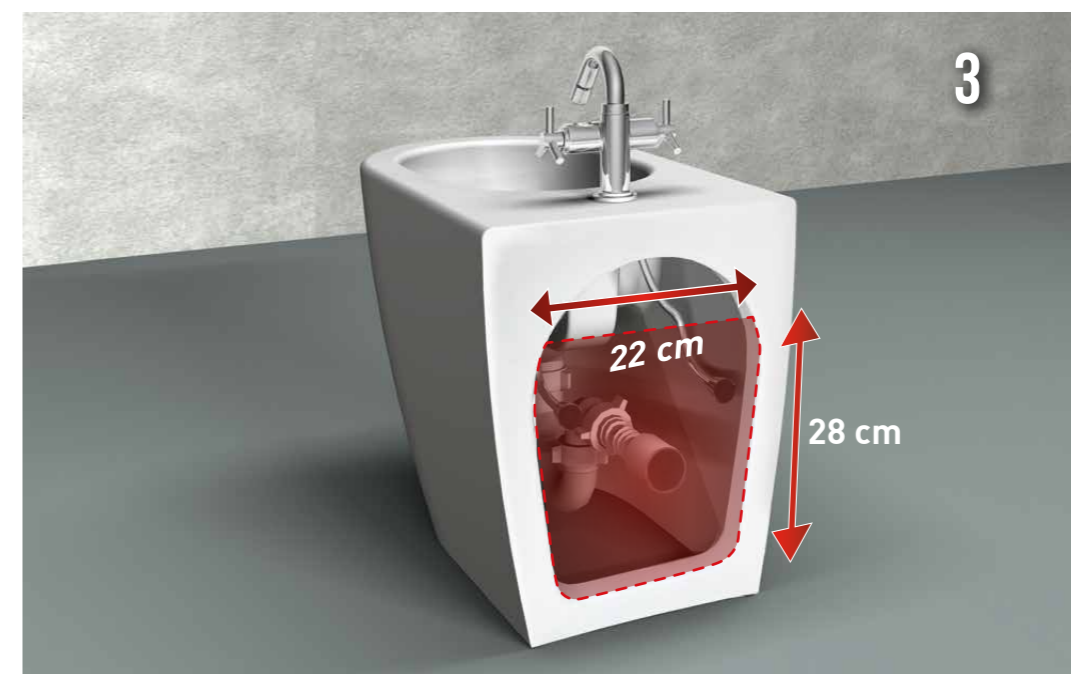

Ampio spazio tecnico per scarico e utenze acqua calda / fredda.

Large technical space for drainage and hot / cold water utilities.

COVER XL

CM 56



COVER XL

Wc e bidet filomuro

cm 56X36 H. 40



COVER XL

Wc e bidet sospesi

cm 56X36



COVER XL

CM 56X36



COVER XL
WC filo-muro scarico pavimento/parete
BTW WC floor-wall trap

COD. AS001



| COD. | KG |
|-------|------|
| AS001 | 30 |
| CTWC | 0,35 |

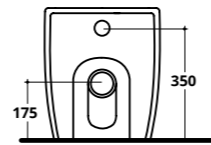
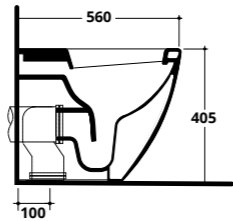
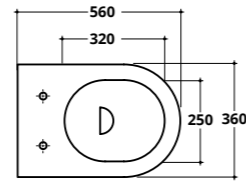

COVER XL

CM 56X36



COVER XL
WC sospeso
Wall hung WC

COD. AS002



| COD. | KG |
|-------|----|
| AS002 | 23 |

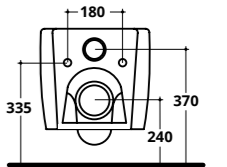
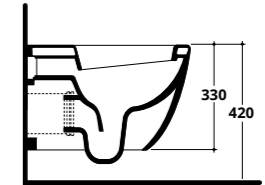
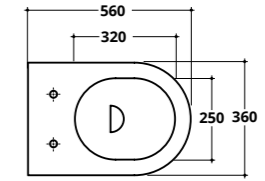

COVER XL
Bidet monoforo con troppopieno
One tap hole BTW bidet with overflow

COD. AS003



| COD. | KG |
|-------|----|
| AS003 | 23 |

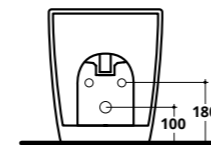
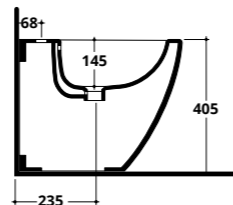
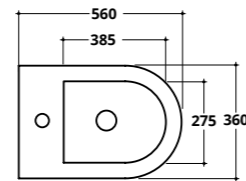

COVER XL
Bidet sospeso monoforo con troppopieno
Wall hung one tap hole bidet with overflow

COD. AS004



| COD. | KG |
|-------|----|
| AS004 | 22 |

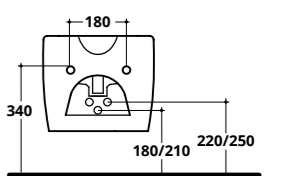
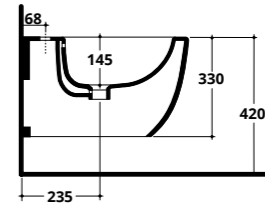
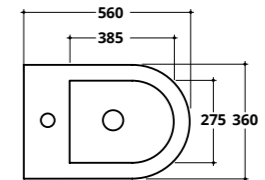

COVER XL - COPRI WC
Copri wc slim soft-close con sgancio rapido
Quick release slim soft-close seat cover

COD. AS007S



Piletta di scarico click-clack con tappo in ceramica universale
Click-clack waste mechanism with universal ceramic cover

GLOSS WHITE **COD. CCNEW**



COVER XL - COPRI WC
Copri wc slim soft-close con sgancio rapido
Quick release slim soft-close seat cover

COD. AS007S



Piletta di scarico click-clack con tappo in ceramica universale
Click-clack waste mechanism with universal ceramic cover

GLOSS WHITE **COD. CCNEW**



Fissaggi in plastica per WC e bidet
Plastic brackets for BTW WC - bidet

COD. FIX01



Fissaggi per WC e bidet sospesi
Fixings for wall hung WC and bidet

COD. FIX02



Staffa di fissaggio WC e bidet sospesi
Bracket for wall hung WC and bidet

COD. FIX03



Espositore metallico per WC e bidet sospesi
Metal display stand for wall hung wc and bidet

COD. MINIEXPO



FUJI

RIMLESS



COPRIWC SOFT-CLOSE
CON SGANCIO RAPIDO
QUICK RELEASE
SOFT-CLOSE SEAT COVER



RISPARMIO IDRICO 3 L
WATER SAVING 3 L

SISTEMA DI SCARICO RIMLESS
RIMLESS SYSTEM

VERSIONI DISPONIBILI / AVAILABLE MODELS
WC FILOMURO / BIDET FILOMURO
BACK TO WALL WC / BACK TO WALL BIDET

FUJI

RIMLESS



FUJI

Wc e bidet filomuro

cm 56X36 H. 40



SOFT CLOSE



Il sistema *Soft Close* permette al sedile e al coperchio di chiudersi lentamente senza il bisogno di accompagnarne la corsa con la mano.

The *Soft Close* system enables the seat and the lid to close slowly without the need to follow the descent by hand.

EASY CLICK



Grazie al sistema *Easy Click* sarà possibile rimuovere il copri vaso in 2 semplici gesti così da consentire una perfetta pulizia.

Thanks to the *Easy-Click* system it is possible to remove the seat cover with 2 simple moves to allow perfect cleaning.

RIMLESS SYSTEM



1



2



53

FUJI RIMLESS

CM 56X36

FUJI

WC RIMLESS filo-muro scarico pavimento/parete
RIMLESS BTW WC floor-wall trap

COD. **FU001**



| COD. | KG |
|--------|------|
| FU001 | 28 |
| CTWC | 0,35 |
| RIDFLU | 0,02 |



RISPARMIO IDRICO 3 L
WATER SAVING 3 L

Per i WC rimless si consiglia di ridurre la pressione dell'acqua e la quantità dei litri di scarico come indicato
For rimless WC pans it is recommended to reduce the water pressure and the flush volume (litres of water) as indicated

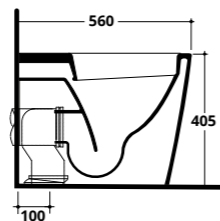
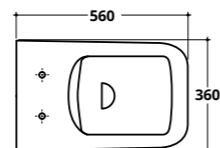

Curva tecnica
Pipe fitting

COD. **CTWC**



Riduttore di flusso
WC flow reducer

COD. **RIDFLU**

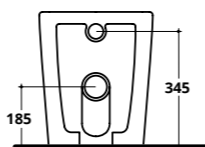

FUJI

Bidet monoforo con troppopieno
One tap hole bidet with overflow

COD. **FU003**



| COD. | KG |
|-------|----|
| FU003 | 23 |

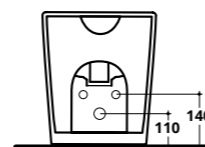
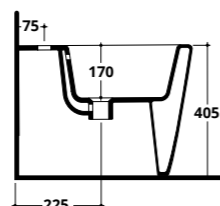
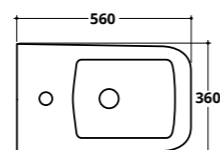

FUJI - COPRI WC

Copri wc slim soft-close con sgancio rapido
Quick release slim soft-close seat cover

COD. **FU007**



Piletta di scarico click-clack con tappo in ceramica universale
Click-clack waste mechanism with universal ceramic cover

GLOSS WHITE COD. **CCNEW**



Fissaggi in plastica per WC e bidet
Plastic brackets for BTW WC - bidet

COD. **FIX01**



FUJI

RIMLESS

cm 56



TAK RIMLESS SOSPESI

COPRIWC SOFT-CLOSE
CON SGANCIO RAPIDO
QUICK RELEASE
SOFT-CLOSE SEAT COVER

RISPARMIO IDRICO 3 L
WATER SAVING 3 L



SISTEMA DI SCARICO RIMLESS
RIMLESS SYSTEM

VERSIONI DISPONIBILI / AVAILABLE MODELS
WC SOSPESO / BIDET SOSPESO
WALL HUNG WC / WALL HUNG BIDET



TAK RIMLESS

Wc e bidet sospesi

cm 52X36



TAK RIMLESS

CM 52X36

TAK RIMLESS
WC sospeso
Wall hung WC

COD. TA013



| COD. | KG |
|--------|------|
| TA013 | 30 |
| RIDFLU | 0,02 |



Per i WC rimless si consiglia di ridurre la pressione dell'acqua e la quantità dei litri di scarico come indicato
For rimless WC pans it is recommended to reduce the water pressure and the flush volume (litres of water) as indicated

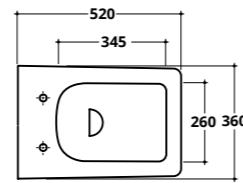

Riduttore di flusso
WC flow reducer
COD. RIDFLU

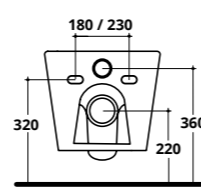
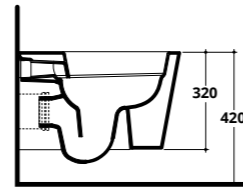

TAK RIMLESS
Bidet sospeso monoforo con troppopieno
Wall hung one tap hole bidet with overflow

COD. TA004



| COD. | KG |
|-------|----|
| TA004 | 24 |

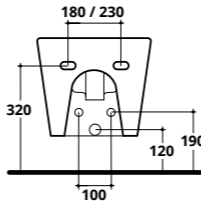
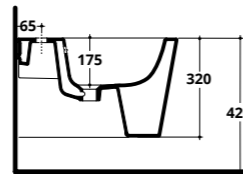
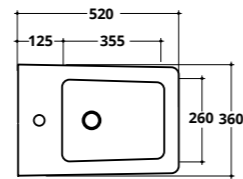

Staffa di fissaggio per WC e bidet sospesi
Bracket for wall hung WC - bidet

COD. FIX03



Piletta di scarico click-clack con tappo in ceramica universale
Click-clack waste mechanism with universal ceramic cover

GLOSS WHITE COD. CCNEW



Espositore metallico per WC e bidet sospesi
Metal display stand for wall hung wc and bidet

COD. MINIEXPO



TAK RIMLESS



IMBALLO COMPLETO
VERSIONE SOSPESI



GLI ACCESSORI PRESENTI NELLA SCATOLA SONO A PAGAMENTO
THE ACCESSORIES CONTAINED IN THE BOX HAVE TO BE PAID FOR SEPARATELY



TAK RIMLESS - COPRI WC
Copri wc slim soft-close con sgancio rapido
Quick release slim soft-close seat cover

COD. TA007S



Fissaggio rapido per WC e bidet sospesi
Quick fixing kit for wall hung WC - bidet

COD. 40951

SISTEMA DI SCARICO RIMLESS
RIMLESS SYSTEM

RISPARMIO IDRICO 3 L
WATER SAVING 3 L



VERSIONI DISPONIBILI / AVAILABLE MODELS
BIDET SOSPESO / BIDET FILOMURO
WALL HUNG BIDET / BACK TO WALL BIDET



VERSIONI DISPONIBILI / AVAILABLE MODELS
WC SOSPESO / WC FILOMURO / WC MONOBLOCCO
WALL HUNG WC / BACK TO WALL WC / CLOSE-COUPLED WC

COPRIWC SOFT-CLOSE
CON SGANCIO RAPIDO
QUICK RELEASE
SOFT-CLOSE SEAT COVER

SOLI RIMLESS FILOMURO

SOLI
RIMLESS

FILOMURO



SOLI RIMLESS

Wc e bidet filomuro

cm 50X36 H. 43



SOLI
RIMLESS

SOSPESI

SOLI RIMLESS

Wc e bidet sospesi

cm 50X36



SOLI
RIMLESS

SOSPESI



SOLI RIMLESS

CM 50X36



RISPARMIO IDRICO 3 L
WATER SAVING 3 L

Per i WC rimless si consiglia di ridurre la pressione dell'acqua e la quantità dei litri di scarico come indicato
For rimless WC pans it is recommended to reduce the water pressure and the flush volume (litres of water) as indicated

SOLI RIMLESS

WC filo-muro scarico pavimento/parete
BTW WC floor-wall trap

COD. **SO012**



| COD. | KG |
|--------|------|
| SO012 | 24 |
| CTWC | 0,35 |
| RIDFLU | 0,02 |

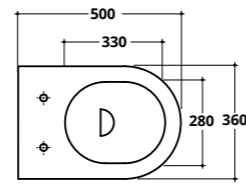

Curva tecnica
Pipe fitting
COD. **CTWC**



Riduttore di flusso
WC flow reducer
COD. **RIDFLU**

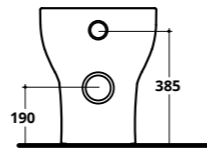
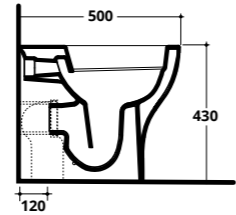

SOLI RIMLESS

Bidet monoforo con troppopieno
One tap hole BTW bidet with overflow

COD. **SO003**



| COD. | KG |
|-------|----|
| SO003 | 24 |

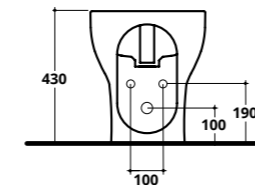
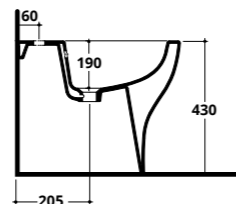
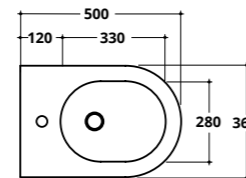

SOLI RIMLESS - CM 62X36 H. 82

WC monoblocco
Close-coupled WC

COD. **SO014**



Cassetta monoblocco
Close-coupled cistern

COD. **SO015**

Meccanismo
Mechanism

COD. **30090**

| COD. | KG |
|-------|------|
| SO014 | 27 |
| SO015 | 10 |
| 30090 | 0,7 |
| CTWC | 0,35 |



Curva tecnica
Pipe fitting
COD. **CTWC**

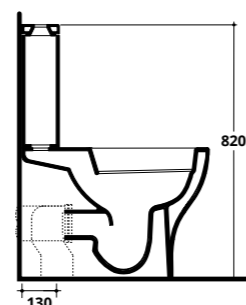
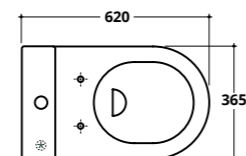

* Entrata acqua
Inlet water

Carico acqua
cassetta
Cistern inlet
water

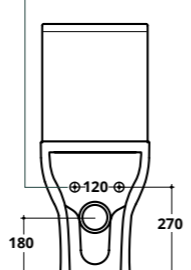

SOLI RIMLESS



IMBALLO COMPLETO
VERSIONE FILO MURO



GLI ACCESSORI PRESENTI NELLA SCATOLA
SONO A PAGAMENTO
THE ACCESSORIES CONTAINED IN THE BOX HAVE TO
BE PAID FOR SEPARATELY



SOLI RIMLESS - COPRI WC
Copri wc slim soft-close con sgancio rapido
Quick release slim soft-close seat cover

COD. **SO007S**



Fissaggi in plastica per WC e bidet
Plastic brackets for BTW WC - bidet

COD. **FIX01**

SOLI RIMLESS

CM 50X36

SOLI RIMLESS
WC sospeso
Wall hung WC

COD. **SO013**



| COD. | KG |
|--------|------|
| SO013 | 22 |
| RIDFLU | 0,02 |



Per i WC rimless si consiglia di ridurre la pressione dell'acqua e la quantità dei litri di scarico come indicato
For rimless WC pans it is recommended to reduce the water pressure and the flush volume (litres of water) as indicated

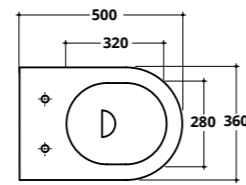

Riduttore di flusso
WC flow reducer
COD. **RIDFLU**

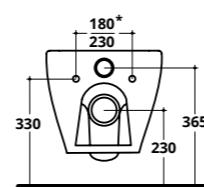
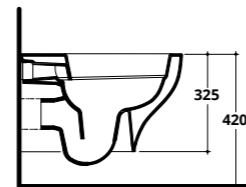

* Disponibile con interasse fori 18 cm o 23 cm
* Available with centre to centre distance of 18 cm or 23 cm

SOLI RIMLESS
Bidet sospeso monoforo con troppopieno
Wall hung one tap hole bidet with overflow

COD. **SO004**



| COD. | KG |
|-------|----|
| SO004 | 22 |

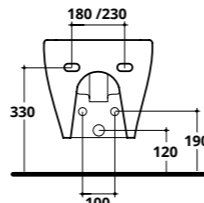
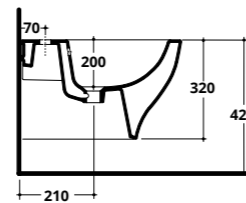
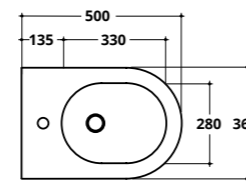

Staffa di fissaggio per WC e bidet sospesi
Bracket for wall hung WC - bidet

COD. **FIX03**



Piletta di scarico click-clack con tappo in ceramica universale
Click-clack waste mechanism with universal ceramic cover

GLOSS WHITE COD. **CCNEW**



Espositore metallico per WC e bidet sospesi
Metal display stand for wall hung wc and bidet

COD. **MINIEXPO**



SOLI RIMLESS



IMBALLO COMPLETO
VERSIONE SOSPESI



GLI ACCESSORI PRESENTI NELLA SCATOLA SONO A PAGAMENTO
THE ACCESSORIES CONTAINED IN THE BOX HAVE TO BE PAID FOR SEPARATELY



SOLI RIMLESS - COPRI WC
Copri wc slim soft-close con sgancio rapido
Quick release slim soft-close seat cover

COD. **SO007S**



Fissaggio rapido per WC e bidet sospesi
Quick fixing kit for wall hung WC - bidet

COD. **40951**

SEVEN

RIMLESS

FILOMURO

RISPARMIO IDRICO 3 L
WATER SAVING 3 L



VERSIONI DISPONIBILI / AVAILABLE MODELS
BIDET SOSPEO / BIDET FILOMURO
WALL HUNG BIDET / BACK TO WALL BIDET



COPRIWC SOFT-CLOSE
CON SGANCIO RAPIDO
QUICK RELEASE
SOFT-CLOSE SEAT COVER

SISTEMA DI
SCARICO RIMLESS
RIMLESS SYSTEM

VERSIONI DISPONIBILI / AVAILABLE MODELS
WC SOSPEO / WC FILOMURO / WC MONOBLOCCO
WALL HUNG WC / BACK TO WALL WC / CLOSE-COUPLED WC

SEVEN
RIMLESS

FILOMURO



SEVEN RIMLESS

Wc e bidet filomuro

cm 50X36 H. 43



SEVEN
RIMLESS

SOSPESI

SEVEN RIMLESS

Wc e bidet sospesi

cm 50X36



RIMLESS SYSTEM



SISTEMA DI SCARICO RIMLESS RIMLESS FLUSHING SYSTEM

Eliminando la brida il wc presenta una superficie totalmente a vista, facile da igienizzare.

By eliminating the rim, the WC has a totally visible surface easy to clean.



SISTEMA DI SCARICO A BRIDA FLUSHING SYSTEM WITH RIM

Sporcizia e batteri si annidano all'interno del solco della brida, dove è praticamente impossibile pulire accuratamente.

Dirt and bacteria settle under the rim, where it is extremely hard to clean thoroughly.

SEVEN RIMLESS

CM 50X36



RISPARMIO IDRICO 3 L
WATER SAVING 3 L

Per i WC rimless si consiglia di ridurre la pressione dell'acqua e la quantità dei litri di scarico come indicato
For rimless WC pans it is recommended to reduce the water pressure and the flush volume (litres of water) as indicated

SEVEN RIMLESS

WC filo-muro scarico pavimento/parete
BTW WC floor-wall trap

COD. SE012



| COD. | KG |
|--------|------|
| SE012 | 24 |
| CTWC | 0,35 |
| RIDFLU | 0,02 |

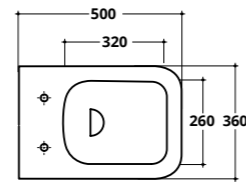

Curva tecnica
Pipe fitting

COD. CTWC



Riduttore di flusso
WC flow reducer

COD. RIDFLU

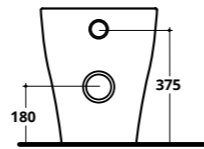
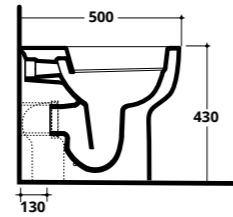

SEVEN RIMLESS



IMBALLO COMPLETO
VERSIONE FILO MURO



GLI ACCESSORI PRESENTI NELLA SCATOLA
SONO A PAGAMENTO
THE ACCESSORIES CONTAINED IN THE BOX HAVE TO
BE PAID FOR SEPARATELY

SEVEN RIMLESS

Bidet monoforo con troppopieno
One tap hole BTW bidet with overflow

COD. SE003



| COD. | KG |
|-------|----|
| SE003 | 24 |

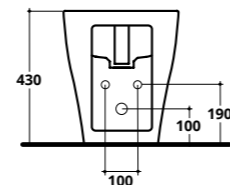
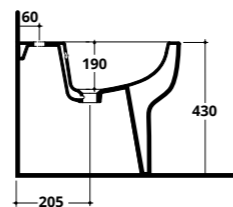
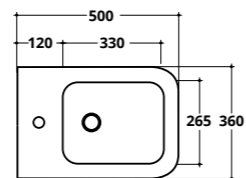

SEVEN RIMLESS - CM 62X35 H. 84
WC monoblocco
Close-coupled WC

COD. SE014



Cassetta monoblocco
Close-coupled cistern

COD. SE015

Meccanismo
Mechanism

COD. 30090

| COD. | KG |
|-------|------|
| SE014 | 28 |
| SE015 | 10 |
| 30090 | 0,7 |
| CTWC | 0,35 |



Curva tecnica
Pipe fitting

COD. CTWC

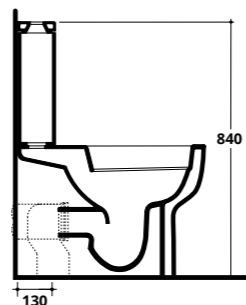
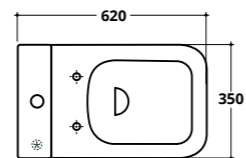

* Entrata acqua
Inlet water

• Carico acqua
cassetta
Cistern inlet
water

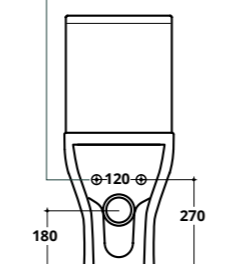

SEVEN RIMLESS - COPRI WC

Copri wc slim soft-close con sgancio rapido
Quick release slim soft-close seat cover

COD. SE007S



Fissaggi in plastica per WC e bidet
Plastic brackets for BTW WC - bidet

COD. FIX01

SEVEN RIMLESS

CM 50X36

SEVEN RIMLESS
WC sospeso
Wall hung WC

COD. SE013



| COD. | KG |
|--------|------|
| SE013 | 22 |
| RIDFLU | 0,02 |



Per i WC rimless si consiglia di ridurre la pressione dell'acqua e la quantità dei litri di scarico come indicato
For rimless WC pans it is recommended to reduce the water pressure and the flush volume (litres of water) as indicated

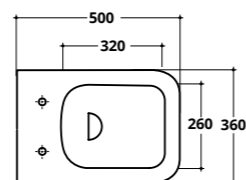

Riduttore di flusso
WC flow reducer
COD. RIDFLU

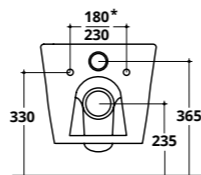
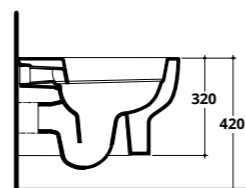

* Disponibile con interasse fori 18 cm o 23 cm
* Available with centre to centre distance of 18 cm or 23 cm

SEVEN RIMLESS
Bidet sospeso monoforo con troppopieno
Wall hung one tap hole bidet with overflow

COD. SE004



| COD. | KG |
|-------|----|
| SE004 | 22 |

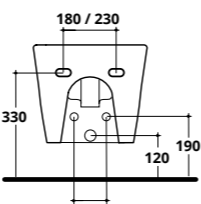
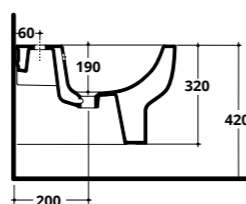
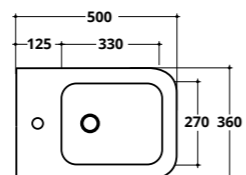

Staffa di fissaggio per WC e bidet sospesi
Bracket for wall hung WC - bidet

COD. FIX03



Piletta di scarico click-clack con tappo in ceramica universale
Click-clack waste mechanism with universal ceramic cover

GLOSS WHITE COD. CCNEW



Espositore metallico per WC e bidet sospesi
Metal display stand for wall hung wc and bidet

COD. MINIEXPO



SEVEN RIMLESS



IMBALLO COMPLETO
VERSIONE SOSPESI



GLI ACCESSORI PRESENTI NELLA SCATOLA
SONO A PAGAMENTO
THE ACCESSORIES CONTAINED IN THE BOX HAVE TO
BE PAID FOR SEPARATELY



SEVEN RIMLESS - COPRI WC
Copri wc slim soft-close con sgancio rapido
Quick release slim soft-close seat cover

COD. SE007S



Fissaggio rapido per WC e bidet sospesi
Quick fixing kit for wall hung WC - bidet

COD. 40951

COVER

COORDINATI

plus+ton®

COLOURS

Tutti i COLORI del bagno **ALTHEA**

plus-ton®



LAVABI
WASHBASINS

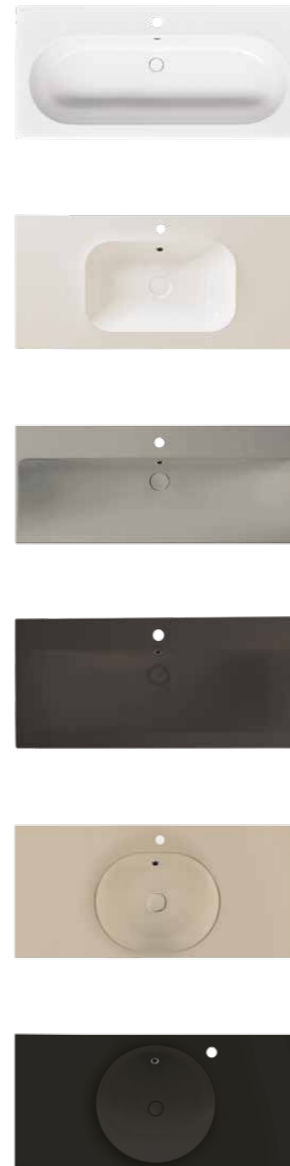

+



WC E BIDET
WC AND BIDET



+

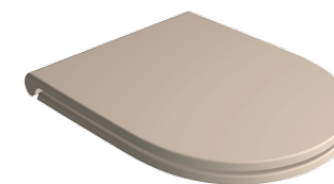

PIATTO DOCCIA UP
UP SHOWER TRAY

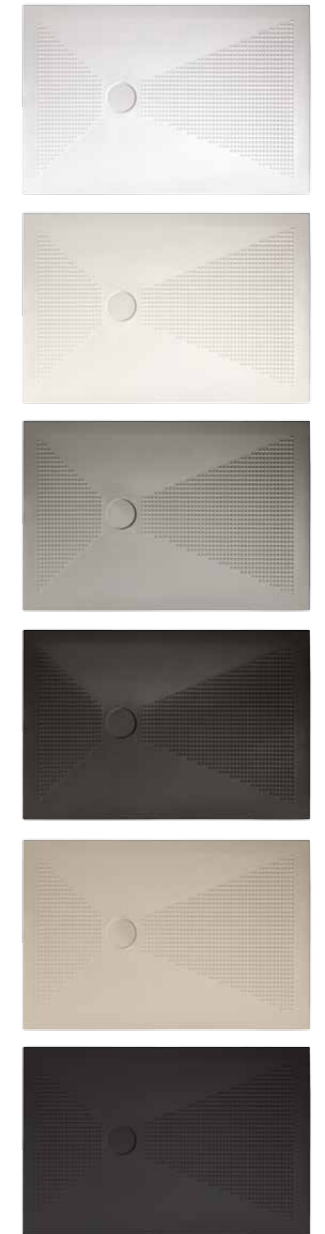

+



COVER RIMLESS plus+ton®

CM 52X36



Per i WC rimless si consiglia di ridurre la pressione dell'acqua e la quantità dei litri di scarico come indicato
For rimless WC pans it is recommended to reduce the water pressure and the flush volume (litres of water) as indicated

COVER RIMLESS PLUS+TON
WC filo-muro scarico pavimento/parete
BTW WC floor-wall trap

COD. 40374R



| COD. | KG |
|--------|------|
| 40374R | 24,5 |
| CTWC | 0,35 |
| RIDFLU | 0,02 |

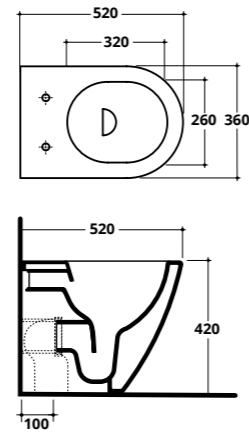

Curva tecnica
Pipe fitting

COD. CTWC



Riduttore di flusso
WC flow reducer

COD. RIDFLU

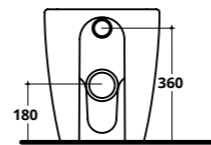
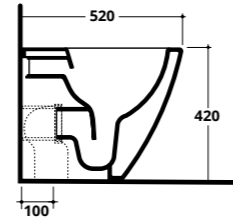

COVER RIMLESS

Wc e bidet filomuro

cm 52X36 H. 42



CEMENTO
#03

COVER RIMLESS PLUS+TON
Bidet monoforo con troppopieno
One tap hole BTW bidet with overflow

COD. 40372R



| COD. | KG |
|--------|----|
| 40372R | 19 |

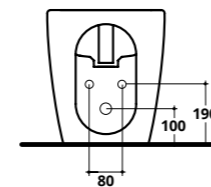
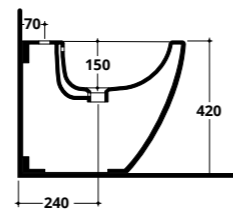
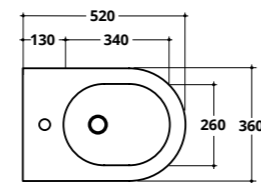

COVER PLUS+TON - COPRI WC
Copri wc slim soft-close con sgancio rapido
Quick release slim soft-close seat cover

COD. 41113.

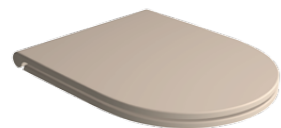

Piletta di scarico click-clack
con tappo in ceramica universale
Click-clack waste mechanism
with universal ceramic cover

PLUS+TON® **COD. PCCNEW**



Fissaggi in plastica per WC e bidet
Plastic brackets for BTW WC - bidet

COD. 40290

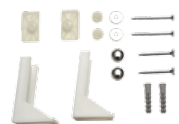

plus+ton® **COLOURS**



COVER RIMLESS plus+ton®

CM 52X36

COVER RIMLESS PLUS+TON
WC sospeso
Wall hung WC

COD. 40375R



| COD. | KG |
|--------|------|
| 40375R | 16,5 |
| RIDFLU | 0,02 |



Per i WC rimless si consiglia di ridurre la pressione dell'acqua e la quantità dei litri di scarico come indicato
For rimless WC pans it is recommended to reduce the water pressure and the flush volume (litres of water) as indicated

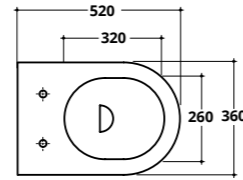

Riduttore di flusso
WC flow reducer
COD. RIDFLU

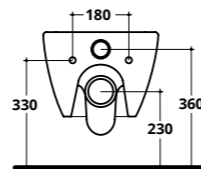
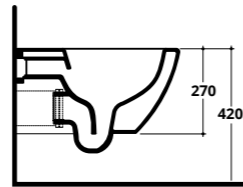

COVER RIMLESS PLUS+TON

Bidet sospeso monoforo con troppopieno
Wall hung one tap hole bidet with overflow

COD. 40373R



| COD. | KG |
|--------|------|
| 40373R | 13,5 |

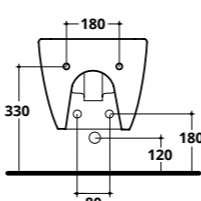
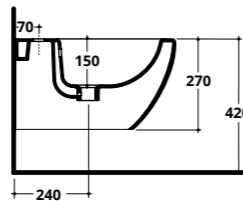
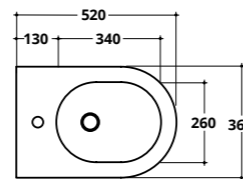

COVER PLUS+TON - COPRI WC

Copri wc slim soft-close con sgancio rapido
Quick release slim soft-close seat cover

COD. 41113.

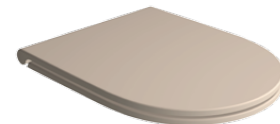

plus+ton® COLOURS



ACCESSORI PER SOSPESI / WALL HUNG ACCESSORIES

Staffa di fissaggio per WC e bidet sospesi
Bracket for wall hung WC - bidet

COD. FIX03



Fissaggio rapido per WC e bidet sospesi
Quick fixing kit for wall hung WC - bidet

COD. 40951



Espositore metallico per WC e bidet sospesi
Metal display stand for wall hung wc and bidet

COD. MINIEXPO



Piletta di scarico click-clack con tappo in ceramica universale
Click-clack waste mechanism with universal ceramic cover

PLUS+TON® **COD. PCCNEW**



LAVABI D'ARREDO

I lavabi d'arredo **Althea** sono caratterizzati da **profili extra sottili**. Disponibili in una grande varietà di misure e forme, possono essere installati in appoggio, sospesi a parete o ad incasso.

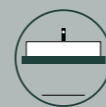

INSTALLAZIONE IN APPOGGIO

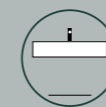

INSTALLAZIONE SOSPESA

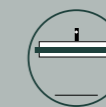

INSTALLAZIONE AD INCASSO



CON TROPPOPIENO



SENZA TROPPOPIENO



KASSEL cm 43x43 h. 15
GLOSS WHITE COD. 41112
PLUS+TON® COD. 41112.



COVER cm 58x35 h. 14
GLOSS WHITE COD. 40234
PLUS+TON® COD. 40234-



SHO cm 58x42 h. 17,8
GLOSS WHITE COD. SHO58
PLUS+TON® COD. PSHO58



COVER cm 70x35 h. 15
GLOSS WHITE COD. 40583
PLUS+TON® COD. PCV70A.



COVER cm 45x35 h. 16
GLOSS WHITE COD. 41850
PLUS+TON® COD. PCV45A.



SPAZIO cm 46x46 h. 15
GLOSS WHITE COD. SPAZIO46#BL
PLUS+TON® COD. SPAZIO46



FINITURE / FINISHES

BIANCO LUCIDO

plus+ton COLOURS

| | | |
|------------|-----------|-------------|
| | | |
| BIANCO #01 | LINO #02 | CEMENTO #03 |
| | | |
| FERRO #05 | BEIGE #06 | NERO #09 |

ACCESSORI / ACCESSORIES

PILETTA DI SCARICO CLICK-CLACK CON TAPPO IN CERAMICA UNIVERSALE
CLICK-CLACK WASTE MECHANISM WITH UNIVERSAL CERAMIC COVER

GLOSS WHITE COD. CCNEW
PLUS+TON® COD. PCCNEW

SIFONE / SIPHON
COD. 31056

FINITURE / FINISHES

BIANCO LUCIDO

plus+ton COLOURS

| | | |
|------------|-----------|-------------|
| | | |
| BIANCO #01 | LINO #02 | CEMENTO #03 |
| | | |
| FERRO #05 | BEIGE #06 | NERO #09 |

ACCESSORI / ACCESSORIES

PILETTA DI SCARICO CLICK-CLACK SENZA TROPPOPIENO CON TAPPO IN CERAMICA UNIVERSALE
CLICK-CLACK WASTE MECHANISM WITHOUT OVERFLOW WITH UNIVERSAL CERAMIC COVER

GLOSS WHITE COD. CCNEWNTTP
PLUS+TON® COD. PCCNEWNTTP

SIFONE / SIPHON
COD. 31056

NEW



JUZO cm 58x40 h. 17
GLOSS WHITE COD. **JUZO#BL**
PLUS+TON® COD. **JUZO**



Troppopieno nascosto
Hidden overflow



KUADRO cm 40x40 h. 15
GLOSS WHITE COD. **40886**
PLUS+TON® COD. **PKU.**



UP cm 55x40 h. 15
GLOSS WHITE COD. **40884**
PLUS+TON® COD. **PUP.**



FINITURE / FINISHES

BIANCO LUCIDO

plus+ton COLOURS

| | | |
|------------|-----------|-------------|
| | | |
| BIANCO #01 | LINO #02 | CEMENTO #03 |
| | | |
| FERRO #05 | BEIGE #06 | NERO #09 |

ACCESSORI / ACCESSORIES

PILETTA DI SCARICO CLICK-CLACK CON TAPPO IN CERAMICA UNIVERSALE
CLICK-CLACK WASTE MECHANISM WITH UNIVERSAL CERAMIC COVER

GLOSS WHITE COD. **CCNEW**

PLUS+TON® COD. **PCCNEW**

SIFONE / SIPHON
COD. **31056**

FINITURE / FINISHES

BIANCO LUCIDO

plus+ton COLOURS

| | | |
|------------|-----------|-------------|
| | | |
| BIANCO #01 | LINO #02 | CEMENTO #03 |
| | | |
| FERRO #05 | BEIGE #06 | NERO #09 |

ACCESSORI / ACCESSORIES

PILETTA DI SCARICO CLICK-CLACK **SENZA TROPPOMPIENO** CON TAPPO IN CERAMICA UNIVERSALE
CLICK-CLACK WASTE MECHANISM **WITHOUT OVERFLOW** WITH UNIVERSAL CERAMIC COVER

GLOSS WHITE COD. **CCNEWNTP**

PLUS+TON® COD. **PCCNEWNTP**

SIFONE / SIPHON
COD. **31056**



DIVA cm 65x46 h. 14
 GLOSS WHITE COD. **41845**
 PLUS+TON® COD. **PDV14.**

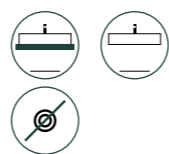

PONS cm 62x44,5 h. 12
 GLOSS WHITE COD. **41023**
 PLUS+TON® COD. **PPNS.**



DIVA cm 65x46 h. 18
 GLOSS WHITE COD. **41846**
 PLUS+TON® COD. **PDV18.**

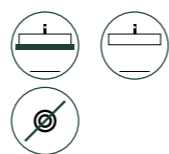

STAR cm 65,5x39 h. 14,5
 GLOSS WHITE COD. **41042**
 PLUS+TON® COD. **P41042**



FINITURE / FINISHES



ACCESSORI / ACCESSORIES



FINITURE / FINISHES



ACCESSORI / ACCESSORIES





IKO cm 44x44 h. 14
GLOSS WHITE COD. **APIKO**



MITO cm 50x40,5 h. 10,5
GLOSS WHITE COD. **APMIT5**



JIN cm 50x39 h. 13
GLOSS WHITE COD. **APJIN**



MYA cm 38,5x38,5 h. 13,5
GLOSS WHITE COD. **APMYA**



FINITURE / FINISHES



BIANCO
LUCIDO

ACCESSORI / ACCESSORIES



PILETTA DI SCARICO CLICK-CLACK
SENZA TROPPOPIENO CON TAPPO IN
CERAMICA UNIVERSALE
CLICK-CLACK WASTE MECHANISM
WITHOUT OVERFLOW WITH UNIVERSAL
CERAMIC COVER
GLOSS WHITE COD. **CCNEWNTP**



BIANCO
LUCIDO

ACCESSORI / ACCESSORIES



PILETTA DI SCARICO CLICK-CLACK
SENZA TROPPOPIENO CON TAPPO IN
CERAMICA UNIVERSALE
CLICK-CLACK WASTE MECHANISM
WITHOUT OVERFLOW WITH UNIVERSAL
CERAMIC COVER
GLOSS WHITE COD. **CCNEWNTP**



SIFONE / SIPHON
COD. **31056**

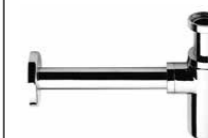

SIFONE / SIPHON
COD. **31056**



HIRO cm 71,5x41 h. 14,5
GLOSS WHITE COD. **APHIR**



AKI cm 45,5x32,5 h. 13,5
GLOSS WHITE COD. **APAKI**



GOA cm 45x40 h. 14,5
GLOSS WHITE COD. **APGOA**



JO cm 50,5x40,5 h. 14
GLOSS WHITE COD. **APJO**



FINITURE / FINISHES



BIANCO
LUCIDO

ACCESSORI / ACCESSORIES



PILETTA DI SCARICO CLICK-CLACK
SENZA TROPPOPIENO CON TAPPO IN
CERAMICA UNIVERSALE
CLICK-CLACK WASTE MECHANISM
WITHOUT OVERFLOW WITH UNIVERSAL
CERAMIC COVER

GLOSS WHITE COD. **CCNEWNTP**

FINITURE / FINISHES



BIANCO
LUCIDO

ACCESSORI / ACCESSORIES



PILETTA DI SCARICO CLICK-CLACK
SENZA TROPPOPIENO CON TAPPO IN
CERAMICA UNIVERSALE
CLICK-CLACK WASTE MECHANISM
WITHOUT OVERFLOW WITH UNIVERSAL
CERAMIC COVER

GLOSS WHITE COD. **CCNEWNTP**



SIFONE / SIPHON
COD. **31056**

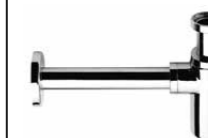

SIFONE / SIPHON
COD. **31056**



TEK cm 51x39 h. 14
GLOSS WHITE COD. **APTEK5**

TEK cm 61x39 h. 14
GLOSS WHITE COD. **APTEK6**

TEK cm 71x39 h. 14
GLOSS WHITE COD. **APTEK7**



KEY cm 40x40 h. 11,5
GLOSS WHITE COD. **APKEY4**

KEY cm 50x40 h. 11,5
GLOSS WHITE COD. **APKEY5**

KEY cm 60x40 h. 11,5
GLOSS WHITE COD. **APKEY6**

KEY cm 80x40 h. 11,5
GLOSS WHITE COD. **APKEY8**



Profili **EXTRA - SOTTILI**
EXTRA – SLIM profiles

FINITURE / FINISHES



BIANCO
LUCIDO

ACCESSORI / ACCESSORIES



PILETTA DI SCARICO CLICK-CLACK
SENZA TROPPOPIENO CON TAPPO IN
CERAMICA UNIVERSALE
CLICK-CLACK WASTE MECHANISM
WITHOUT OVERFLOW WITH UNIVERSAL
CERAMIC COVER
GLOSS WHITE COD. **CCNEWNTP**



SIFONE / SIPHON
COD. **31056**

FINITURE / FINISHES



BIANCO
LUCIDO

ACCESSORI / ACCESSORIES



PILETTA DI SCARICO CLICK-CLACK
SENZA TROPPOPIENO CON TAPPO IN
CERAMICA UNIVERSALE
CLICK-CLACK WASTE MECHANISM
WITHOUT OVERFLOW WITH UNIVERSAL
CERAMIC COVER
GLOSS WHITE COD. **CCNEWNTP**

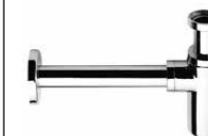

SIFONE / SIPHON
COD. **31056**



HIRO2 cm 71x48,5 h. 16,5
 GLOSS WHITE COD. **HIRO2**
 PLUS+TON® COD. **PHIRO2**

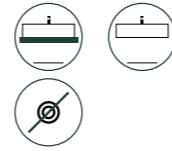

COVER cm 80x46 DX
 GLOSS WHITE COD. **40813**
 PLUS+TON® COD. **PCV80D.**



COVER cm 80x46 SX
 GLOSS WHITE COD. **40820**
 PLUS+TON® COD. **PCV80S.**



FINITURE / FINISHES



ACCESSORI / ACCESSORIES



FINITURE / FINISHES



ACCESSORI / ACCESSORIES





CLEVER cm 50x39 h. 4
 GLOSS WHITE COD. **30382**
 PLUS+TON® COD. **P30382**

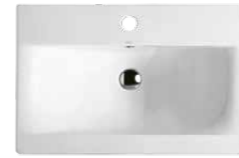
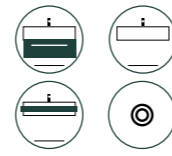

CLEVER cm 60x39 h. 4
 GLOSS WHITE COD. **30383**
 PLUS+TON® COD. **P30383**

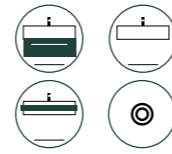

JUST cm 50x41 h. 6,5
 GLOSS WHITE COD. **JUST541**
 PLUS+TON® COD. **PJUST541**

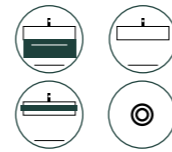

PINK cm 61x46 h. 3,5
 GLOSS WHITE COD. **40920**
 PLUS+TON® COD. **PPK61.**

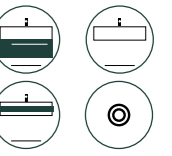

JET cm 60x39 h. 8
 GLOSS WHITE COD. **41738**
 PLUS+TON® COD. **P41738**

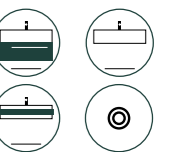

FINITURE / FINISHES



ACCESSORI / ACCESSORIES



FINITURE / FINISHES



ACCESSORI / ACCESSORIES





MOVADO 45 cm 45x35 h. 3
 GLOSS WHITE COD. **41698**
 PLUS+TON® COD. **MOV45CTP**



DIVA Slim cm 65x43 h. 4
 GLOSS WHITE COD. **41107**
 PLUS+TON® COD. **PDVI**



MOVADO 58 cm 58x35 h. 3
 GLOSS WHITE COD. **41697**
 PLUS+TON® COD. **MOV58CTP**



FLY cm 66x42 h. 4
 GLOSS WHITE COD. **41043**
 PLUS+TON® COD. **P41043**



SMALL cm 22x40,5 h. 6
 GLOSS WHITE COD. **40216**
 PLUS+TON® COD. **P40216**

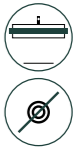

FINITURE / FINISHES

BIANCO LUCIDO

plus+ton COLOURS

| | | |
|------------|-----------|-------------|
| | | |
| BIANCO #01 | LINO #02 | CEMENTO #03 |
| | | |
| FERRO #05 | BEIGE #06 | NERO #09 |

ACCESSORI / ACCESSORIES

PILETTA DI SCARICO CLICK-CLACK CON TAPPO IN CERAMICA UNIVERSALE
 CLICK-CLACK WASTE MECHANISM WITH UNIVERSAL CERAMIC COVER

GLOSS WHITE COD. **CCNEW**

PLUS+TON® COD. **PCCNEW**

SIFONE / SIPHON
 COD. **31056**

FINITURE / FINISHES

BIANCO LUCIDO

plus+ton COLOURS

| | | |
|------------|-----------|-------------|
| | | |
| BIANCO #01 | LINO #02 | CEMENTO #03 |
| | | |
| FERRO #05 | BEIGE #06 | NERO #09 |

ACCESSORI / ACCESSORIES

PILETTA DI SCARICO CLICK-CLACK CON TAPPO IN CERAMICA UNIVERSALE
 CLICK-CLACK WASTE MECHANISM WITH UNIVERSAL CERAMIC COVER

GLOSS WHITE COD. **CCNEW**

PLUS+TON® COD. **PCCNEW**

PILETTA DI SCARICO CLICK-CLACK **SENZA TROPPOPIENO** CON TAPPO IN CERAMICA UNIVERSALE
 CLICK-CLACK WASTE MECHANISM **WITHOUT OVERFLOW** WITH UNIVERSAL CERAMIC COVER

GLOSS WHITE COD. **CCNEWNTP**

PLUS+TON® COD. **PCCNEWNTP**



**PILETTA DI SCARICO CLICK-CLACK
CON TAPPO IN CERAMICA UNIVERSALE**
CLICK-CLACK WASTE MECHANISM
WITH UNIVERSAL CERAMIC COVER

BIANCO LUCIDO **COD. CCNEW**
PLUS+TON® **COD. PCCNEW**

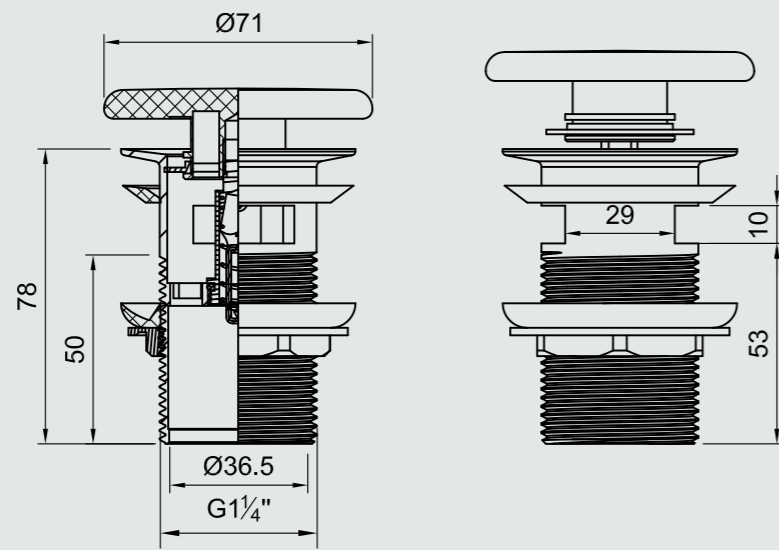

FINITURE / FINISHES



BIANCO
LUCIDO



COMPATIBILE
CON TUTTI
I LAVABI CON
TROPPOPIENO



**PILETTA DI SCARICO CLICK-CLACK
SENZA TROPPOPIENO CON TAPPO IN CERAMICA UNIVERSALE**
CLICK-CLACK WASTE MECHANISM
WITHOUT OVERFLOW WITH UNIVERSAL CERAMIC COVER

BIANCO LUCIDO **COD. CCNEWNTP**
PLUS+TON® **COD. PCCNEWNTP**

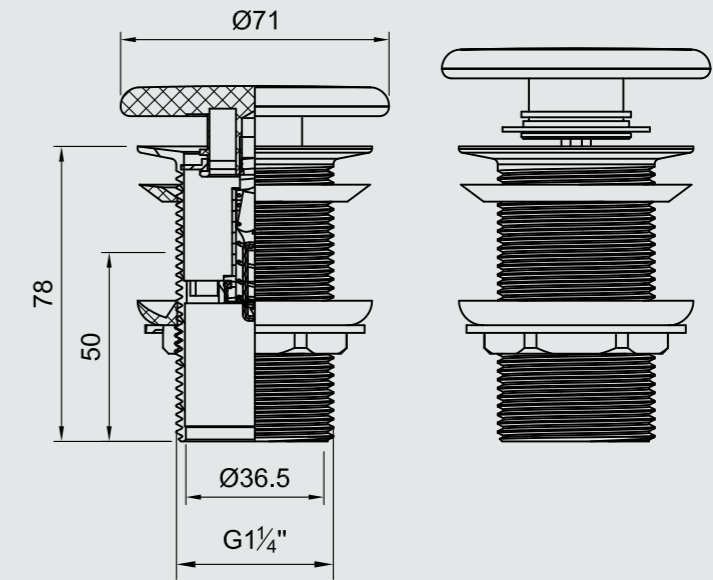

FINITURE / FINISHES



BIANCO
LUCIDO



COMPATIBILE
CON TUTTI
I LAVABI SENZA
TROPPOPIENO

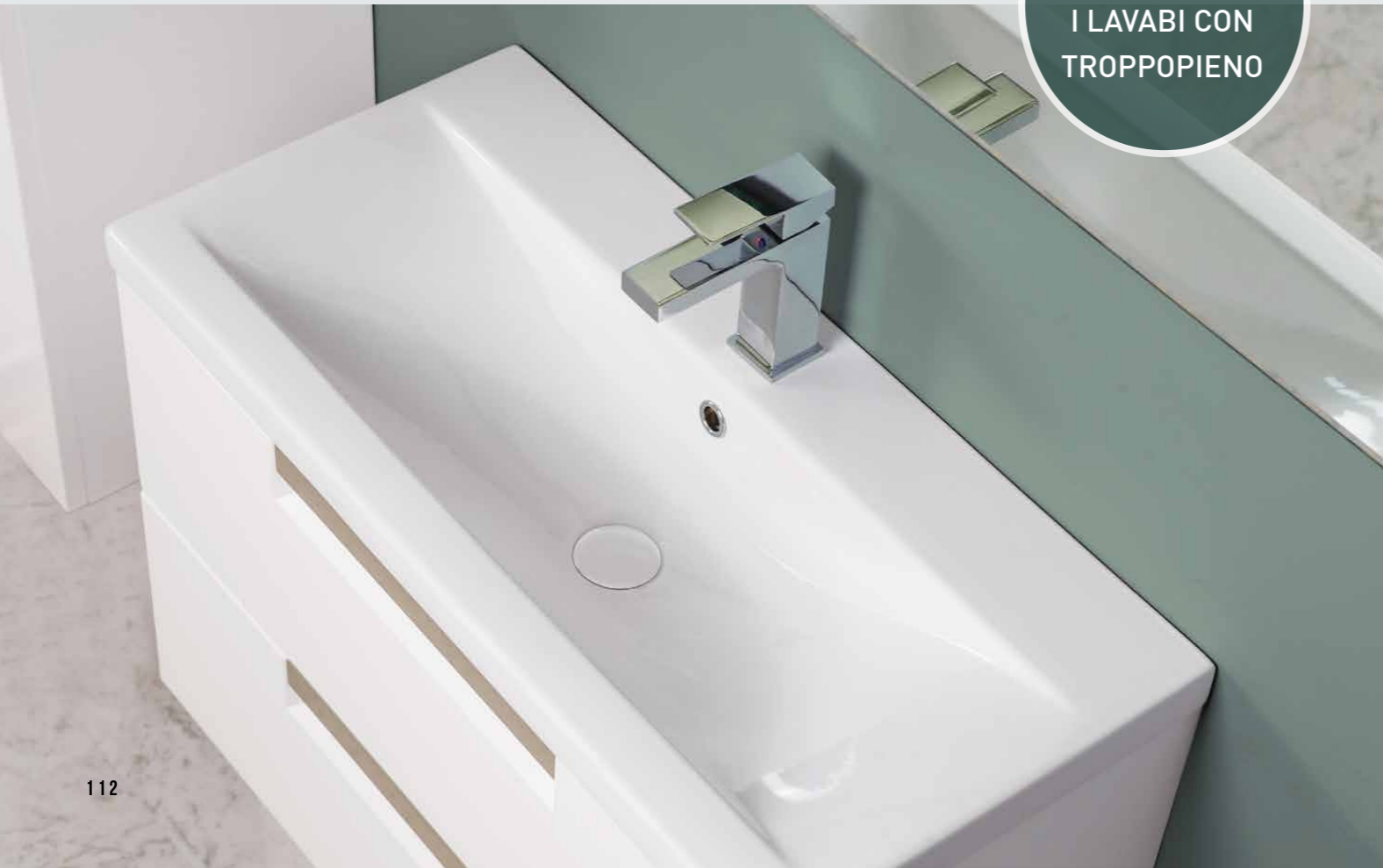

KASSEL43X43 Lavabo d'appoggio con troppopieno

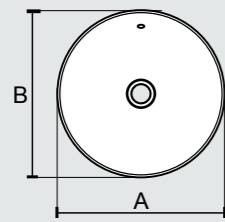

| COD. | cm A X B | H | H vasca | KG |
|----------|----------|-------|---------|----|
| ○ 41112 | cm 43x43 | cm 15 | cm 10 | 7 |
| ● 41112. | | | | |

FINITURE / FINISHES



SHO58X42 Lavabo d'appoggio con troppopieno

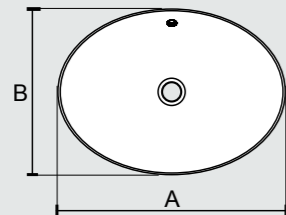

| COD. | cm A X B | H | H vasca | KG |
|----------|----------|---------|---------|----|
| ○ SHO58 | cm 58x42 | cm 17,8 | cm 13 | 12 |
| ● PSHO58 | | | | |

FINITURE / FINISHES



COVER45X35 Lavabo d'appoggio con troppopieno

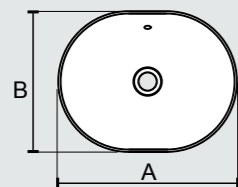

| COD. | cm A X B | H | H vasca | KG |
|-----------|----------|-------|---------|----|
| ○ 41850 | cm 45x35 | cm 16 | cm 12 | 9 |
| ● PCV45A. | | | | |

FINITURE / FINISHES



COVER58X35 Lavabo d'appoggio senza troppopieno

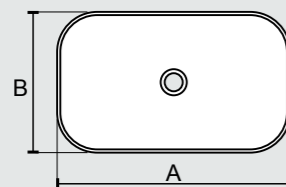

| COD. | cm A X B | H | H vasca | KG |
|----------|----------|-------|---------|----|
| ○ 40234 | cm 58x35 | cm 14 | cm 12,5 | 8 |
| ● 40234- | | | | |

FINITURE / FINISHES



COVER70X35 Lavabo d'appoggio senza troppopieno

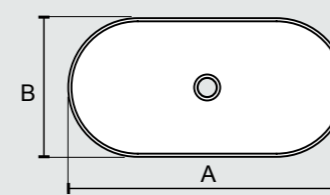

| COD. | cm A X B | H | H vasca | KG |
|-----------|----------|-------|---------|------|
| ○ 40583 | cm 70x35 | cm 15 | cm 13 | 13,5 |
| ● PCV70A. | | | | |

FINITURE / FINISHES



KUADRO40X40 Lavabo d'appoggio senza troppopieno

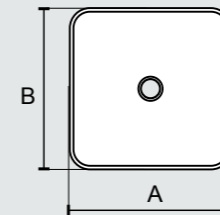

| COD. | cm A X B | H | H vasca | KG |
|---------|----------|-------|---------|----|
| ○ 40886 | cm 40x40 | cm 15 | cm 13 | 10 |
| ● PKU. | | | | |

FINITURE / FINISHES



UP55X40 Lavabo d'appoggio senza troppopieno

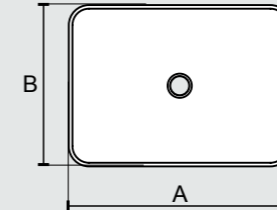

| COD. | cm A X B | H | H vasca | KG |
|---------|----------|-------|---------|----|
| ○ 40884 | cm 55x40 | cm 15 | cm 13 | 13 |
| ● PUP. | | | | |

FINITURE / FINISHES



SPAZIO46X46 Lavabo d'appoggio o incasso senza troppopieno

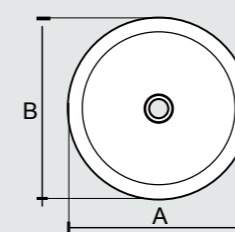

| COD. | cm A X B | H | H vasca | KG |
|---------------|----------|-------|---------|----|
| ○ SPAZIO46#BL | cm 46x46 | cm 15 | cm 12 | 7 |
| ● SPAZIO46 | | | | |

FINITURE / FINISHES



JUZO58X40 Lavabo d'appoggio con troppopieno

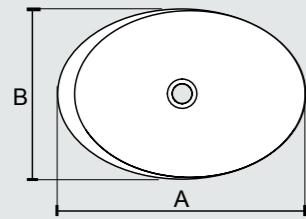

| COD. | cm A X B | H | H vasca | KG |
|-----------|----------|---------|---------|------|
| ○ JUZO#BL | cm 58x40 | cm 16,5 | cm 12 | 13,7 |
| ● JUZO | | | | |

FINITURE / FINISHES



BIANCO LUCIDO



DIVA65X46 H. 14 Lavabo d'appoggio senza troppopieno con foro miscelatore

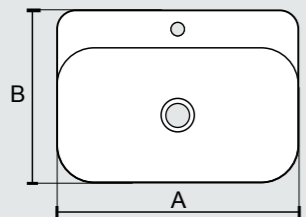

| COD. | cm A X B | H | H vasca | KG |
|----------|----------|-------|---------|----|
| ○ 41845 | cm 65x46 | cm 14 | cm 10 | 16 |
| ● PDV14. | | | | |

FINITURE / FINISHES

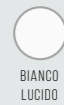

BIANCO LUCIDO



DIVA65X46 H. 18 Lavabo d'appoggio senza troppopieno con foro miscelatore

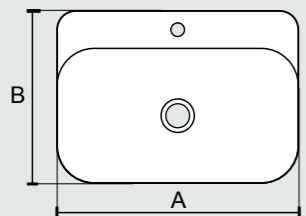

| COD. | cm A X B | H | H vasca | KG |
|----------|----------|-------|---------|----|
| ○ 41846 | cm 65x46 | cm 18 | cm 14 | 20 |
| ● PDV18. | | | | |

FINITURE / FINISHES



BIANCO LUCIDO



PONS62X44 Lavabo d'appoggio senza troppopieno

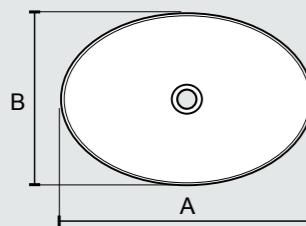

| COD. | cm A X B | H | H vasca | KG |
|---------|------------|-------|---------|----|
| ○ 41023 | cm 62x44,5 | cm 12 | cm 9 | 10 |
| ● PPNS. | | | | |

FINITURE / FINISHES



BIANCO LUCIDO



STAR65X39 Lavabo d'appoggio senza troppopieno con foro miscelatore

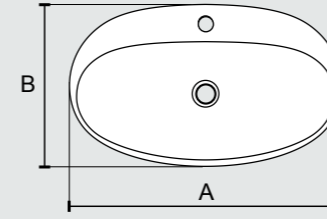

| COD. | cm A X B | H | H vasca | KG |
|----------|------------|---------|---------|----|
| ○ 41042 | cm 65x39,5 | cm 14,5 | cm 10 | 13 |
| ● P41042 | | | | |

FINITURE / FINISHES



BIANCO LUCIDO



IKO44X44 Lavabo d'appoggio senza troppopieno

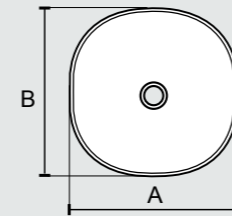

| COD. | cm A X B | H | H vasca | KG |
|-------|----------|-------|---------|----|
| APIKO | cm 44x44 | cm 14 | cm 11 | 8 |

FINITURE / FINISHES



BIANCO LUCIDO

JIN50X39 Lavabo d'appoggio senza troppopieno

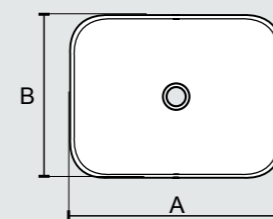

| COD. | cm A X B | H | H vasca | KG |
|-------|----------|-------|---------|------|
| APJIN | cm 50x39 | cm 13 | cm 11 | 10,7 |

FINITURE / FINISHES



BIANCO LUCIDO

MITO50X40 Lavabo d'appoggio senza troppopieno

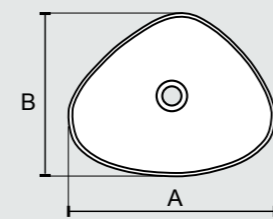

| COD. | cm A X B | H | H vasca | KG |
|--------|------------|---------|---------|----|
| APMIT5 | cm 50x40,5 | cm 10,5 | cm 9 | 8 |

FINITURE / FINISHES



BIANCO LUCIDO

MYA38X38 Lavabo d'appoggio senza troppopieno

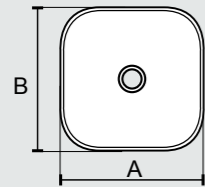

| COD. | cm A X B | H | H vasca | KG |
|-------|--------------|---------|---------|-----|
| APMYA | cm 38,5x38,5 | cm 13,5 | cm 11,5 | 8,4 |

FINITURE / FINISHES



HIRO71X41 Lavabo d'appoggio senza troppopieno

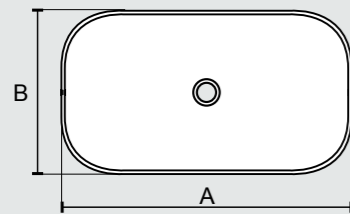

| COD. | cm A X B | H | H vasca | KG |
|-------|------------|---------|---------|------|
| APHIR | cm 71,5x41 | cm 14,5 | cm 12 | 14,2 |

FINITURE / FINISHES



GOA45X40 Lavabo d'appoggio senza troppopieno

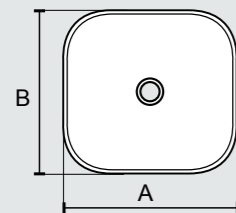

| COD. | cm A X B | H | H vasca | KG |
|-------|----------|---------|---------|----|
| APGOA | cm 45X40 | cm 14,5 | cm 12 | 10 |

FINITURE / FINISHES



AKI45X32 Lavabo d'appoggio senza troppopieno

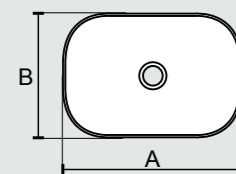

| COD. | cm A X B | H | H vasca | KG |
|-------|--------------|---------|---------|----|
| APAKI | cm 45,5x32,5 | cm 13,5 | cm 10,5 | 7 |

FINITURE / FINISHES



JO50X40 Lavabo d'appoggio senza troppopieno

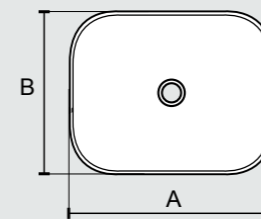

| COD. | cm A X B | H | H vasca | KG |
|------|--------------|-------|---------|----|
| APJO | cm 50,5x40,5 | cm 14 | cm 11 | 11 |

FINITURE / FINISHES



TEK51X39 - 61X39 - 71X39 Lavabo d'appoggio senza troppopieno

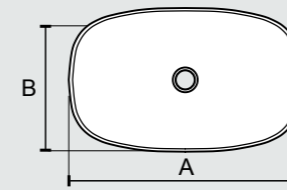

| COD. | cm A X B | H | H vasca | KG |
|--------|----------|-------|---------|------|
| APTEK5 | cm 51x39 | cm 14 | cm 11 | 7,5 |
| APTEK6 | cm 61x39 | cm 14 | cm 11 | 9 |
| APTEK7 | cm 71x39 | cm 14 | cm 11 | 10,5 |

FINITURE / FINISHES



KEY40X40 - 50X40 - 60X40 - 80X40 Lavabo d'appoggio senza troppopieno con foro miscelatore

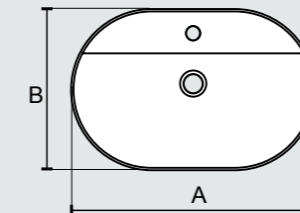

| COD. | cm A X B | H | H vasca | KG |
|--------|----------|---------|---------|------|
| APKEY4 | cm 40X40 | cm 11,5 | cm 8,5 | 7,4 |
| APKEY5 | cm 50X40 | cm 11,5 | cm 8,5 | 8,5 |
| APKEY6 | cm 60X40 | cm 11,5 | cm 8,5 | 11,5 |
| APKEY8 | cm 80X40 | cm 11,5 | cm 8,5 | 13 |

FINITURE / FINISHES



HIRO271X48 Lavabo sospeso o d'appoggio senza troppopieno

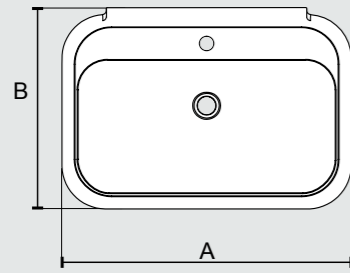

| COD. | cm A X B | H | H vasca | KG |
|----------|------------|---------|---------|----|
| ○ HIRO2 | cm 71x48,5 | cm 16,5 | cm 13 | 14 |
| ● PHIRO2 | | | | |

FINITURE / FINISHES



BIANCO LUCIDO



COVER80X46 DX Lavabo sospeso con troppopieno

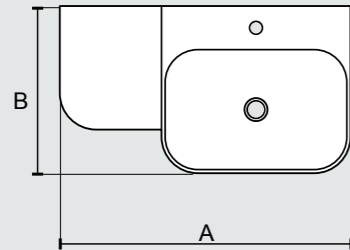

| COD. | cm A X B | H vasca | KG |
|-----------|----------|---------|----|
| ○ 40813 | cm 80x46 | cm 12,5 | 17 |
| ● PCV80D. | | | |

FINITURE / FINISHES



BIANCO LUCIDO



COVER80X46 SX Lavabo sospeso con troppopieno

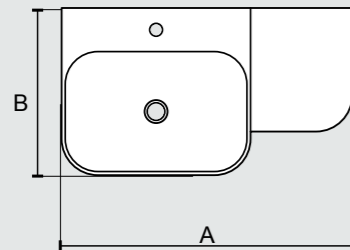

| COD. | cm A X B | H vasca | KG |
|-----------|----------|---------|----|
| ○ 40820 | cm 80x46 | cm 12,5 | 17 |
| ● PCV80D. | | | |

FINITURE / FINISHES



BIANCO LUCIDO



CLEVER Lavabo monoforo con troppopieno

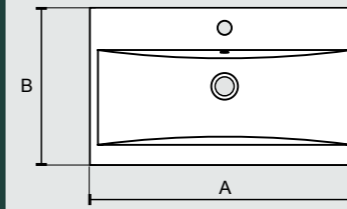

| COD. | cm A X B | H | H vasca | KG |
|----------|----------|--------|---------|----|
| ○ 30382 | cm 50x39 | cm 4,5 | cm 14 | 11 |
| ● P30382 | | | | |
| ○ 30383 | cm 60x39 | cm 4,5 | cm 14 | 14 |
| ● P30383 | | | | |

FINITURE / FINISHES



BIANCO LUCIDO



JUST Lavabo monoforo con troppopieno

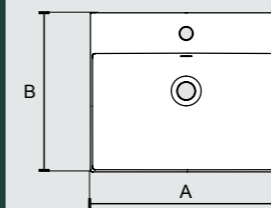

| COD. | cm A X B | H | H vasca | KG |
|------------|----------|--------|---------|----|
| ○ JUST541 | cm 51x42 | cm 6,5 | cm 12 | 12 |
| ● PJUST541 | | | | |

FINITURE / FINISHES



BIANCO LUCIDO



PINK Lavabo monoforo con troppopieno

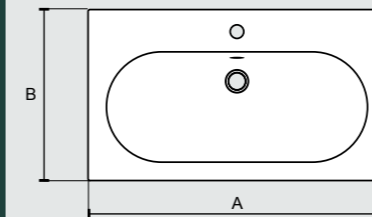

| COD. | cm A X B | H | H vasca | KG |
|----------|----------|--------|---------|----|
| ○ 40920 | cm 61x46 | cm 3,5 | cm 13 | 16 |
| ● PPK61. | | | | |

FINITURE / FINISHES



BIANCO LUCIDO



JET Lavabo monoforo con troppopieno

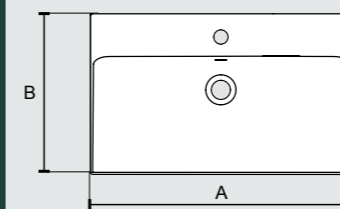

| COD. | cm A X B | H | H vasca | KG |
|----------|--------------|------|---------|----|
| ○ 41738 | cm 64,5x42,5 | cm 8 | cm 12,5 | 14 |
| ● P41738 | | | | |

FINITURE / FINISHES



BIANCO LUCIDO



MOVADO45X35 Lavabo da incasso con troppopieno

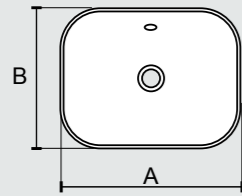

| COD. | cm A X B | H | H vasca | KG |
|------------|----------|------|---------|----|
| ○ 41698 | cm 45x35 | cm 3 | cm 14 | 6 |
| ● MOV45CTP | | | | |

FINITURE / FINISHES



BIANCO LUCIDO



MOVADO58X35 Lavabo da incasso con troppopieno

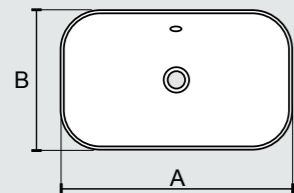

| COD. | cm A X B | H | H vasca | KG |
|------------|----------|------|---------|----|
| ○ 41697 | cm 58x35 | cm 3 | cm 14 | 9 |
| ● MOV58CTP | | | | |

FINITURE / FINISHES



BIANCO LUCIDO



DIVA65X43 Lavabo da incasso senza troppopieno con foro miscelatore

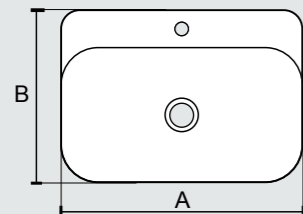

| COD. | cm A X B | H | H vasca | KG |
|---------|----------|------|---------|----|
| ○ 41107 | cm 65x43 | cm 4 | cm 12,5 | 11 |
| ● PDVI. | | | | |

FINITURE / FINISHES



BIANCO LUCIDO



FLY66X42 Lavabo da incasso con troppopieno e foro miscelatore

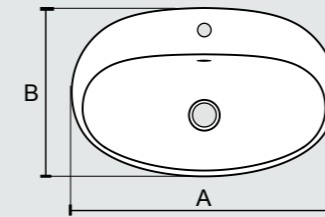

| COD. | cm A X B | H | H vasca | KG |
|----------|----------|------|---------|----|
| ○ 41043 | cm 66x42 | cm 4 | cm 12 | 15 |
| ● P41043 | | | | |

FINITURE / FINISHES



BIANCO LUCIDO



SMALL22X40 Lavabo da incasso senza troppopieno con foro miscelatore

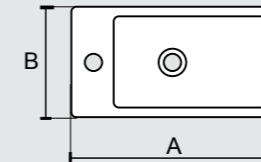

| COD. | cm A X B | H | H vasca | KG |
|----------|------------|------|---------|----|
| ○ 40216 | cm 22X40,5 | cm 6 | cm 7 | 4 |
| ● P40216 | | | | |

FINITURE / FINISHES



BIANCO LUCIDO

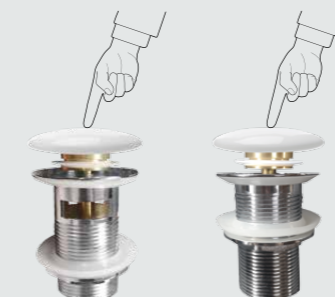

PILETTA DI SCARICO CLICK-CLACK CON TAPPO IN CERAMICA UNIVERSALE
CLICK-CLACK WASTE MECHANISM WITH UNIVERSAL CERAMIC COVER

BIANCO LUCIDO **COD. CCNEW**

PLUS+TON® **COD. PCCNEW**

PILETTA DI SCARICO CLICK-CLACK SENZA TROPPOPIENO CON TAPPO IN CERAMICA UNIVERSALE
CLICK-CLACK WASTE MECHANISM WITHOUT OVERFLOW WITH UNIVERSAL CERAMIC COVER

BIANCO LUCIDO **COD. CCNEWNTTP**

PLUS+TON® **COD. PCCNEWNTTP**

FINITURE / FINISHES



BIANCO LUCIDO



SIFONE
SIPHON

COD. 31056

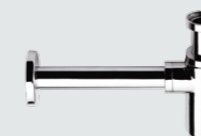



PIATTI DOCCIA

ULTRASOTTILI
CERAMICA / EFFETTO PIETRA

La gamma di piatti doccia **Althea** rappresenta la più completa proposta per finiture, colori e misure presente sul mercato. Realizzati in ceramica o con materiali pregiati composti da minerali naturali e resine che conferiscono le più alte prestazioni funzionali ed estetiche, offrono svariate soluzioni di tendenza, nel rispetto di praticità, comfort e sicurezza.

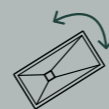

REVERSIBILITÀ DI MONTAGGIO

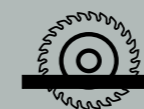

TAGLIABILE A MISURA



TEXTURE ANTISCIVOLO



INSTALLABILE A PAVIMENTO O FILOPAVIMENTO



Tutti i piatti doccia Plus+ton®
sono **TAGLIABILI SU MISURA** in
cantiere o da Althea con apposito
modulo di taglio.

UP - JO'

PIATTI DOCCIA
IN CERAMICA
H 3 CM

PIATTO DOCCIA UP H 3 CM

plus-ton® - DISPONIBILE ANCHE IN BIANCO LUCIDO / ALSO AVAILABLE IN GLOSS WHITE

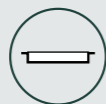
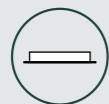
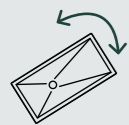

cm 70x90

- COD. UPC79
- COD. UPCM79

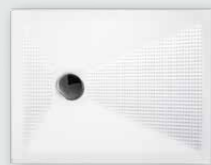

cm 70x100

- COD. UPC710
- COD. UPCM710

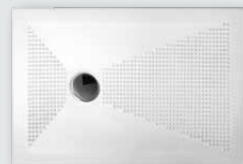

cm 70x120

- COD. UPC712
- COD. UPCM712

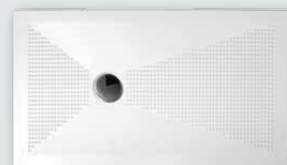

cm 70x140

- COD. UPC714
- COD. UPCM714



cm 80x80

- COD. UPC88
- COD. UPCM88

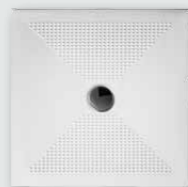

cm 80x100

- COD. UPC810
- COD. UPCM810

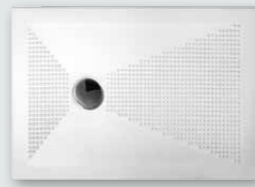

cm 80x120

- COD. UPC812
- COD. UPCM812

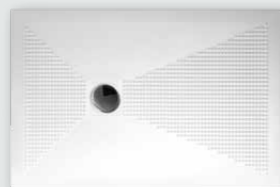

cm 80x140

- COD. UPC814
- COD. UPCM814

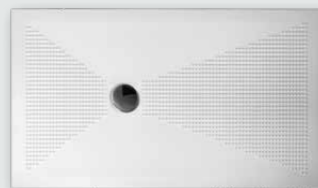

cm 90x120

- COD. UPC912
- COD. UPCM912

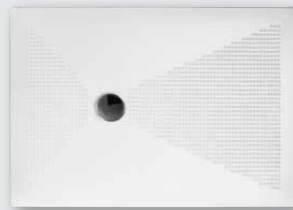

cm 90x140

- COD. UPC914
- COD. UPCM914

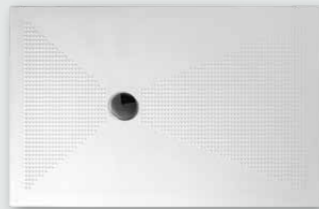

cm 90x160

- COD. UPC916
- COD. UPCM916

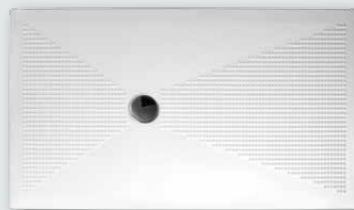

PIATTO DOCCIA JÓ H 3 CM

plus-ton®

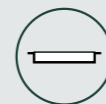
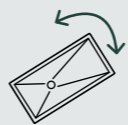

cm 70x90

- COD. JO79



cm 70x100

- COD. JO710



cm 70x120

- COD. JO712



cm 70x140

- COD. JO714



cm 80x80

- COD. JO88

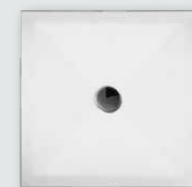

cm 80x100

- COD. JO810

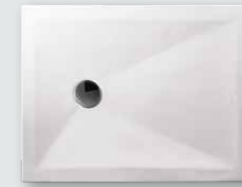

cm 80x120

- COD. JO812



cm 80x140

- COD. JO814



cm 90x90

- COD. JO99

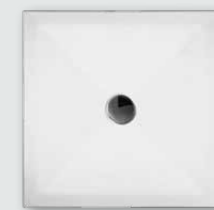

cm 90x120

- COD. JO912



cm 90x140

- COD. JO914



cm 90x160

- COD. JO916





UP

PIATTO DOCCIA
IN CERAMICA
H 3 CM

PIATTO DOCCIA UP H 3 CM

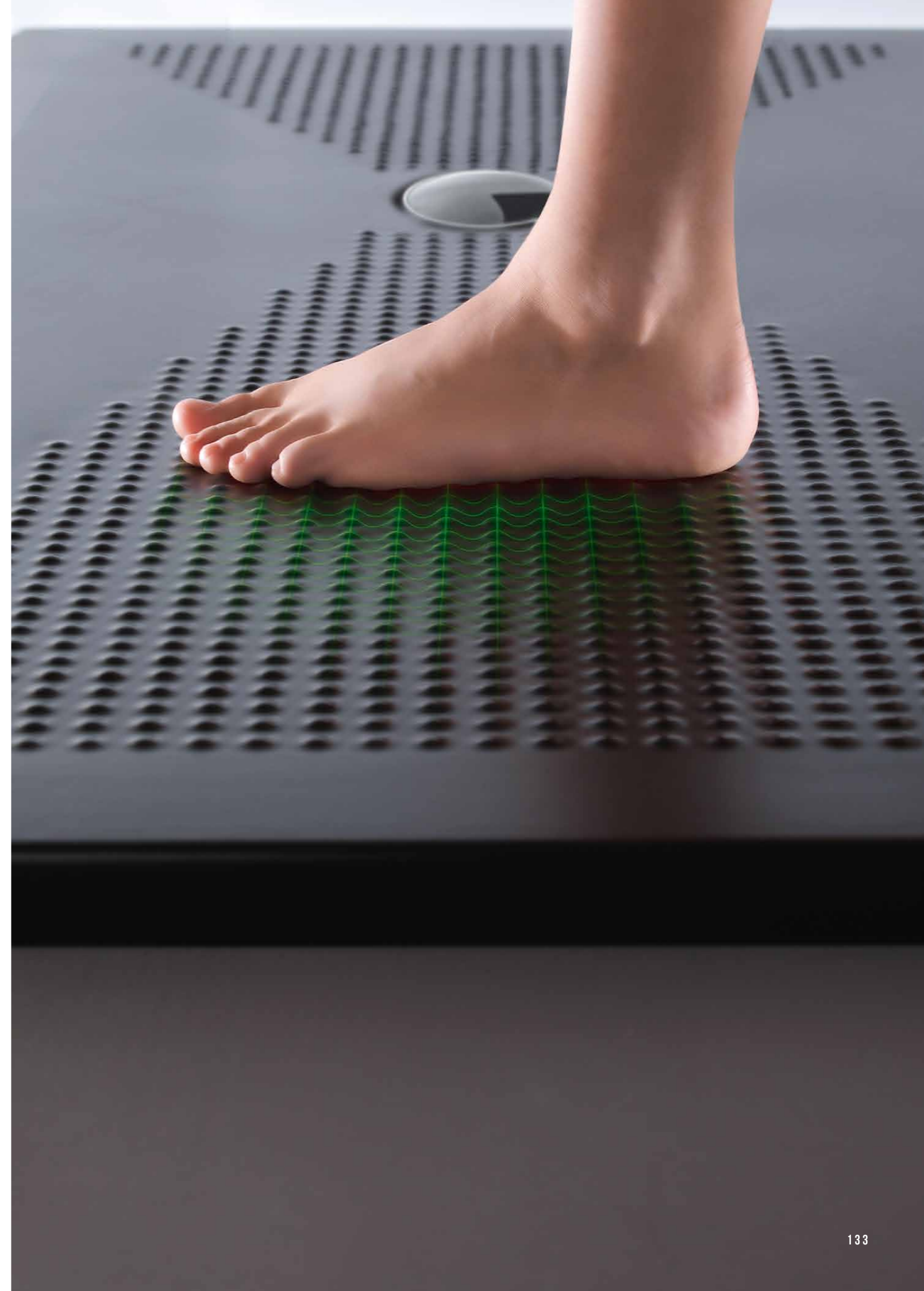
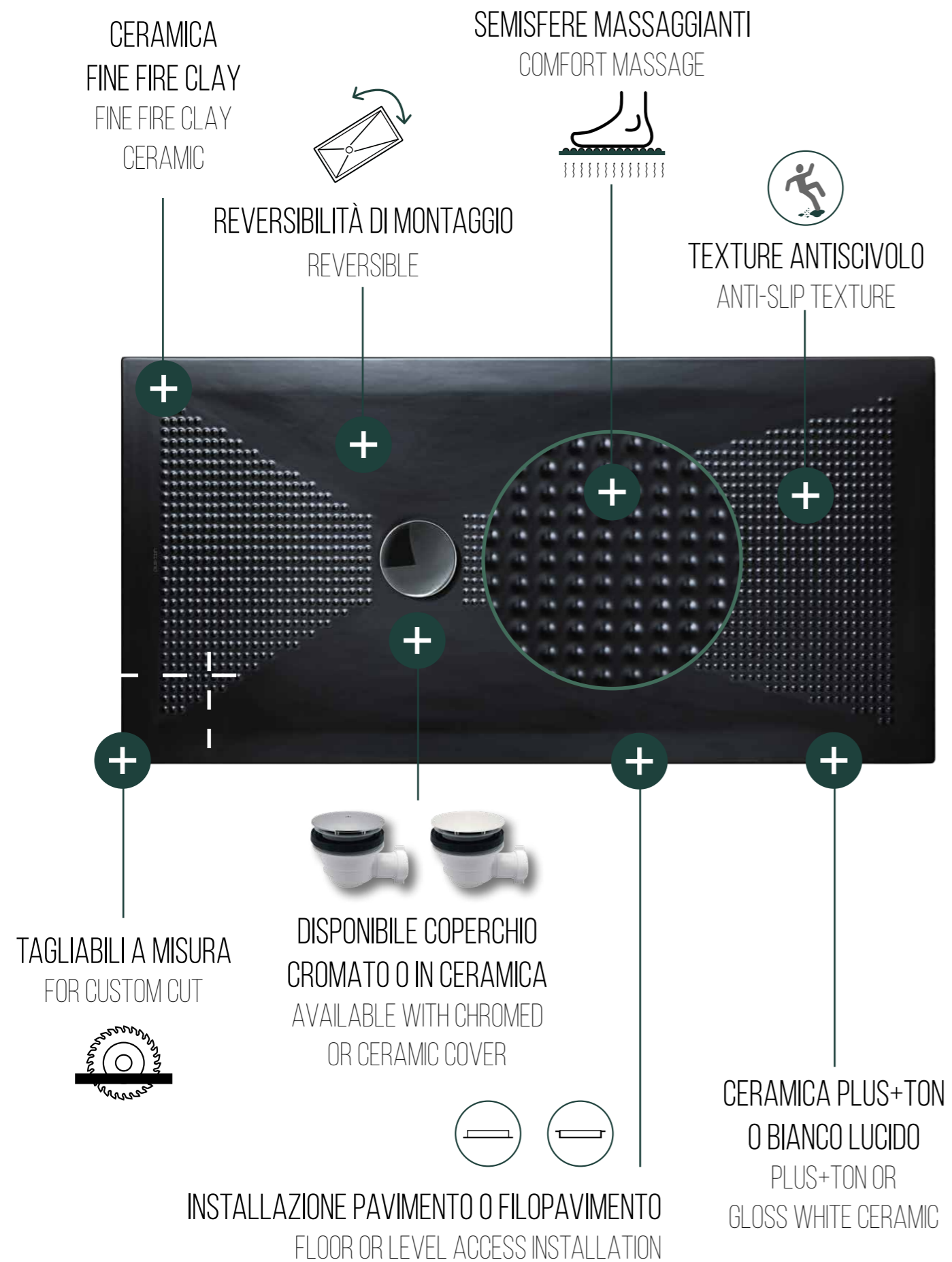



UP
CM 120X80



plus-ton
CEMENTO
#03

plus-ton COLOURS



BIANCO #01 LINO #02 CEMENTO #03 FERRO #05 BEIGE #06 NERO #09

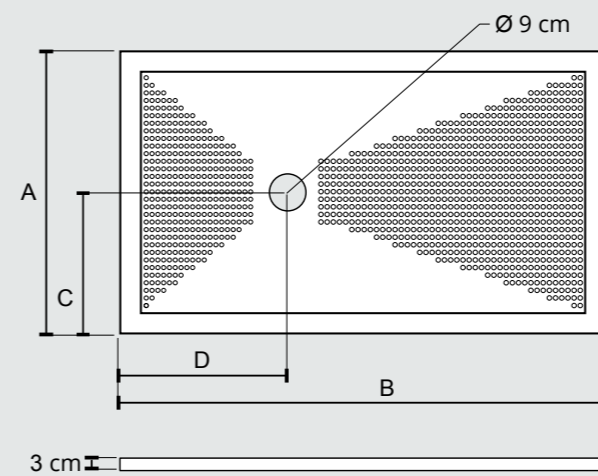
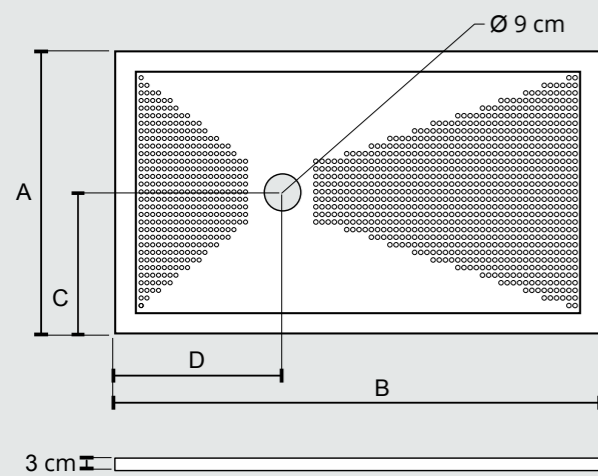

CONSIGLIATO ABBINAMENTO CON:
SUGGESTED COMBINATION WITH:

Scarico sifonato ed ispezionabile
Siphoned and inspectable drain



Coperchio in ABS cromato
Chromed ABS cover
cod. SCPD90



Coperchio in ceramica - BIANCO LUCIDO
Ceramic cover - GLOSS WHITE
cod. SCPD90C#BL



Coperchio in ceramica - PLUS+TON
Ceramic cover - PLUS+TON
cod. SCPD90C



CONSIGLIATO ABBINAMENTO CON:
SUGGESTED COMBINATION WITH:

Scarico sifonato ed ispezionabile
Siphoned and inspectable drain



Coperchio in ABS cromato
Chromed ABS cover
cod. SCPD90



Coperchio in ceramica - BIANCO LUCIDO
Ceramic cover - GLOSS WHITE
cod. SCPD90C#BL



Coperchio in ceramica - PLUS+TON
Ceramic cover - PLUS+TON
cod. SCPD90C

UP 70

| COD. | cm A X B | cm C | cm D | KG |
|-----------------------|-----------|-------|-------|----|
| ○ UPC79 ● UPCM79 | cm 70X90 | cm 35 | cm 26 | 22 |
| ○ UPC710 ● UPCM710 | cm 70X100 | cm 35 | cm 31 | 24 |
| ○ UPC712 ● UPCM712 | cm 70X120 | cm 35 | cm 41 | 26 |
| ○ UPC714 ● UPCM714 | cm 70X140 | cm 35 | cm 51 | 31 |

UP 90

| COD. | cm A X B | cm C | cm D | KG |
|-----------------------|-----------|-------|-------|----|
| ○ UPC912 ● UPCM912 | cm 90X120 | cm 45 | cm 41 | 36 |
| ○ UPC914 ● UPCM914 | cm 90X140 | cm 45 | cm 51 | 39 |
| ○ UPC916 ● UPCM916 | cm 90X160 | cm 45 | cm 61 | 45 |

> Per il colore aggiungere la sigla relativa alla colorazione scelta dopo il codice prodotto
For the coloured shower trays add the code of the needed colour after the product code

UP 80

| COD. | cm A X B | cm C | cm D | KG |
|-----------------------|-----------|-------|-------|----|
| ○ UPC88 ● UPCM88 | cm 80X80 | cm 40 | cm 40 | 20 |
| ○ UPC810 ● UPCM810 | cm 80X100 | cm 40 | cm 31 | 25 |
| ○ UPC812 ● UPCM812 | cm 80X120 | cm 40 | cm 41 | 34 |
| ○ UPC814 ● UPCM814 | cm 80X140 | cm 40 | cm 51 | 36 |

> Per il colore aggiungere la sigla relativa alla colorazione scelta dopo il codice prodotto
For the coloured shower trays add the code of the needed colour after the product code



JÓ
 PIATTO DOCCIA
IN CERAMICA
H 3 CM

PIATTO DOCCIA JÓ H 3 CM

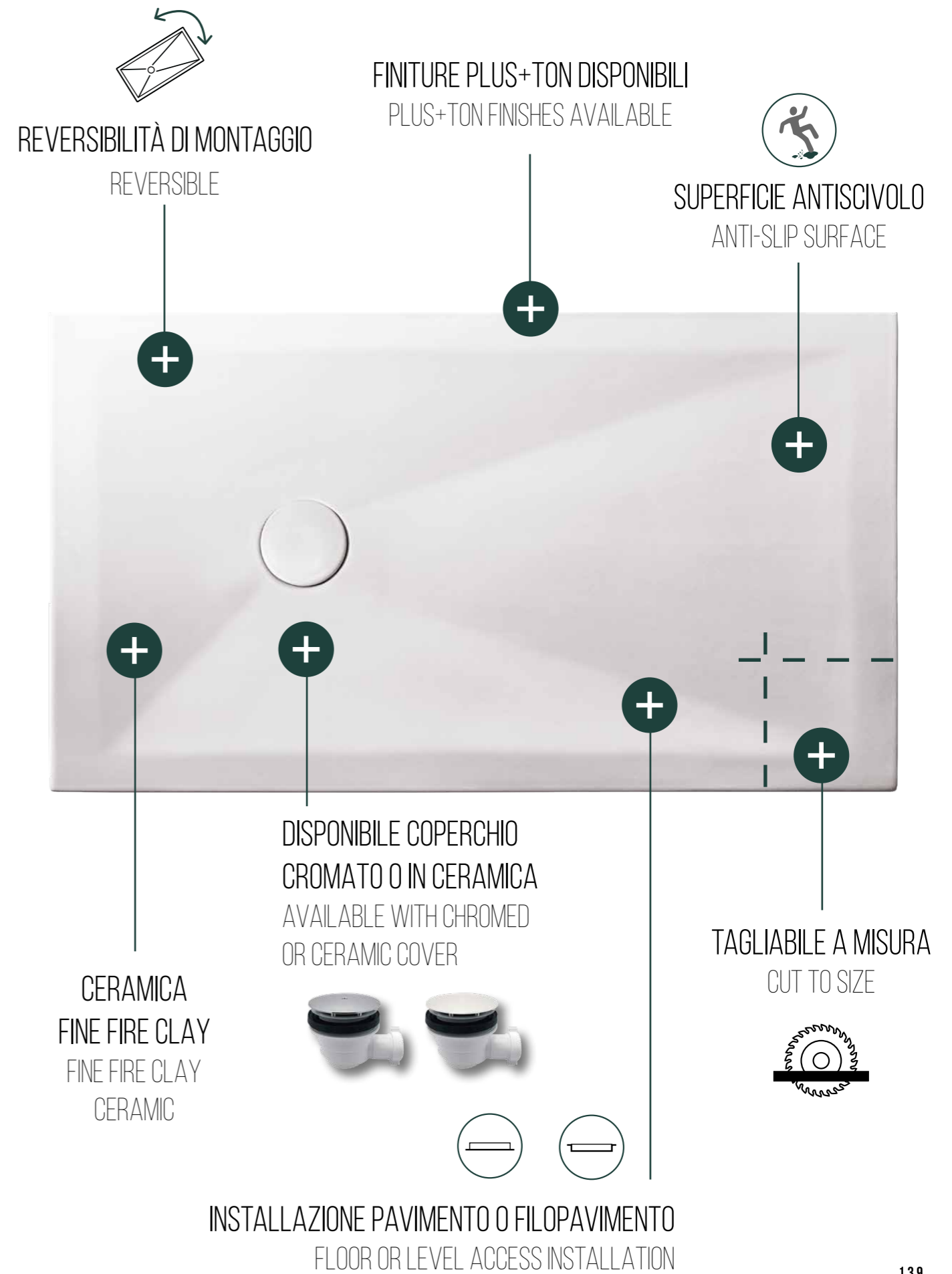

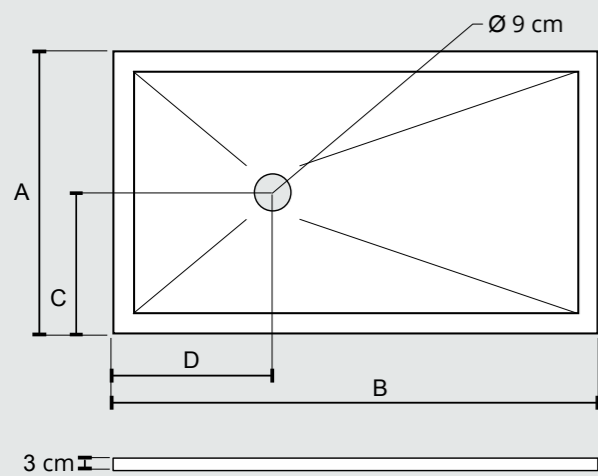

plus+ton COLOURS

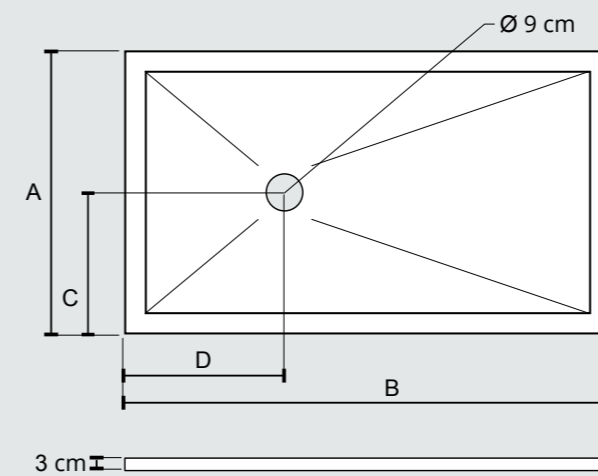

plus+ton COLOURS



CONSIGLIATO ABBINAMENTO CON:
SUGGESTED COMBINATION WITH:

Scarico sifonato ed ispezionabile
Siphoned and inspectable drain

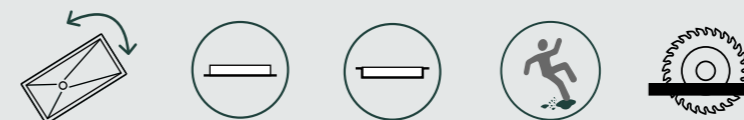

CONSIGLIATO ABBINAMENTO CON:
SUGGESTED COMBINATION WITH:

Scarico sifonato ed ispezionabile
Siphoned and inspectable drain



JÓ 70

| COD. | cm A X B | cm C | cm D | KG |
|-------|-----------|-------|-------|----|
| JO79 | cm 70X90 | cm 35 | cm 26 | 22 |
| JO710 | cm 70X100 | cm 35 | cm 31 | 24 |
| JO712 | cm 70X120 | cm 35 | cm 41 | 26 |
| JO714 | cm 70X140 | cm 35 | cm 51 | 31 |

JÓ 90

| COD. | cm A X B | cm C | cm D | KG |
|-------|-----------|-------|-------|----|
| JO99 | cm 90X90 | cm 45 | cm 45 | 26 |
| JO912 | cm 90X120 | cm 45 | cm 41 | 36 |
| JO914 | cm 90X140 | cm 45 | cm 51 | 39 |
| JO916 | cm 90X160 | cm 45 | cm 61 | 45 |

JÓ 80

| COD. | cm A X B | cm C | cm D | KG |
|-------|-----------|-------|-------|----|
| JO88 | cm 80X80 | cm 40 | cm 40 | 20 |
| JO810 | cm 80X100 | cm 40 | cm 31 | 25 |
| JO812 | cm 80X120 | cm 40 | cm 41 | 34 |
| JO814 | cm 80X140 | cm 40 | cm 51 | 36 |

> Per il colore aggiungere la sigla relativa alla colorazione scelta dopo il codice prodotto
For the coloured shower trays add the code of the needed colour after the product code

> Per il colore aggiungere la sigla relativa alla colorazione scelta dopo il codice prodotto
For the coloured shower trays add the code of the needed colour after the product code

Nome e cognome / Ragione sociale:

Partita IVA o Cod. Fiscale:

Indirizzo:

CAP: Provincia: Stato:

Numero di telefono: Numero fax:

Indirizzo mail:

Modello Piatto doccia:

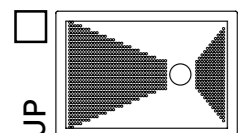

Dimensione (cm):

| cm | 70 | 80 | 90 | 100 | 120 | 140 | 160 |
|----|----|----|----|-----|-----|-----|-----|
| 70 | ■ | ■ | | | | | ■ |
| 80 | ■ | | ■ | | | | ■ |
| 90 | | ■ | ■ | ■ | | | |

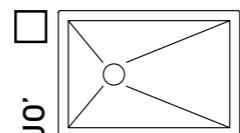

Dimensione (cm):

| cm | 70 | 80 | 90 | 100 | 120 | 140 | 160 |
|----|----|----|----|-----|-----|-----|-----|
| 70 | ■ | ■ | | | | | ■ |
| 80 | ■ | | ■ | | | | ■ |
| 90 | | ■ | ■ | ■ | | | |

Colore:

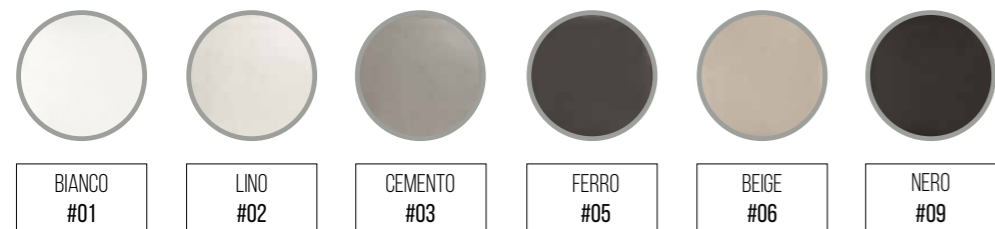

Quantità:

Taglio su misura

Utilizzare il grafico allegato e tracciare le linee di taglio, indicando le relative misure.

Entro 24 ore lavorative dall'invio del presente modulo riceverà la nostra conferma con verifica delle lavorazioni.

I dati personali richiesti in fase di inoltro dell'ordine sono raccolti e trattati al fine di soddisfare le espresse richieste del cliente e non verranno in nessun caso e a nessun titolo ceduti a terzi.

Ceramica Althea SpA garantisce ai propri clienti il rispetto della normativa di trattamento dei dati personali, disciplinata dal codice della privacy di cui al DL 196 del 30.06.03.

Alcuni esempi di tagli su misura:

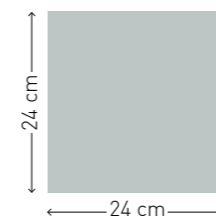
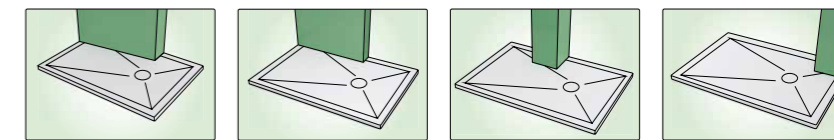

Lo spazio evidenziato con il riquadro verde non può subire operazioni di taglio.

Scala 1:10

N.B. Le parti del piatto doccia interessate dal taglio devono sempre aderire alle pareti e/o ai pilastri.

Per qualsiasi altro utilizzo l'azienda non si assume responsabilità.

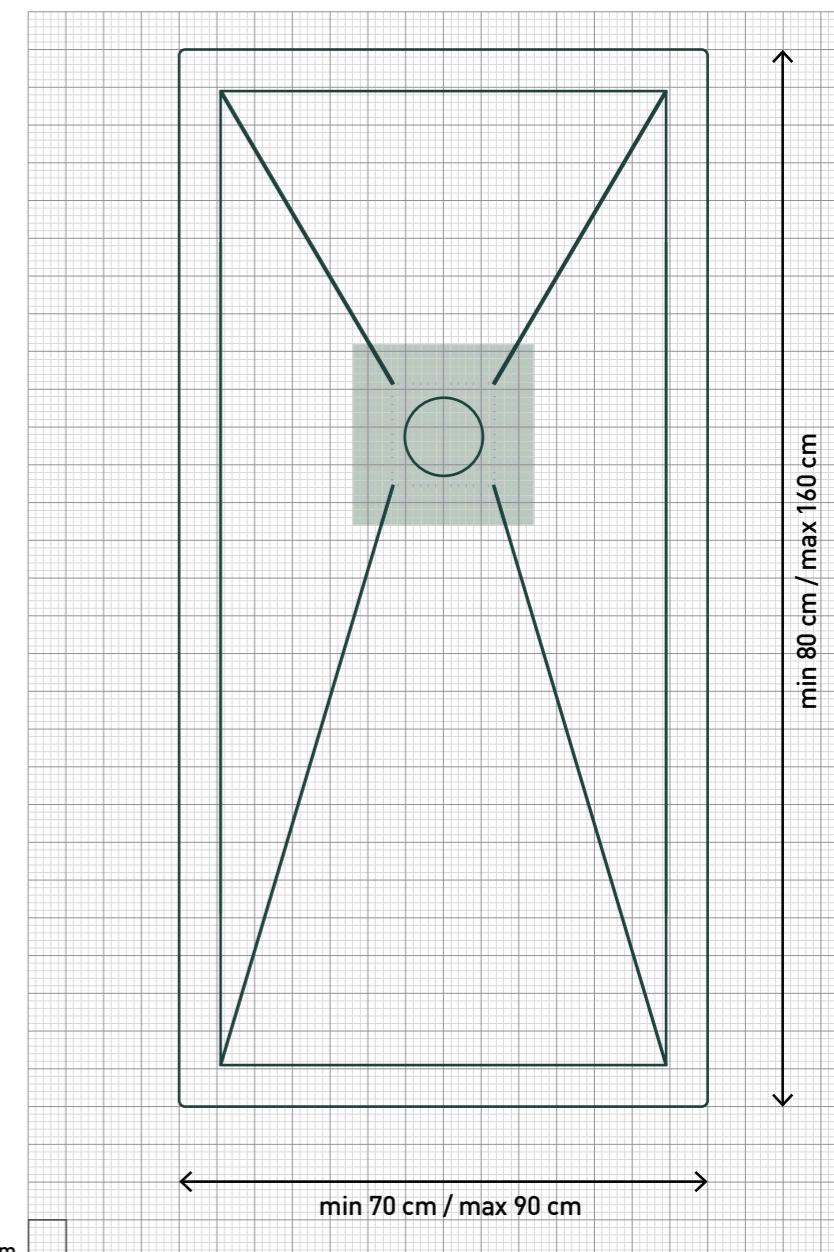

Inquadra con la fotocamera del telefono il **codice QR** per visualizzare il **modulo di taglio** sul nostro sito web



E' garantito un taglio perfetto:
basterà disegnare sullo schema le linee di taglio, indicando le relative misure.

Timbro e firma

.....



ITO
PIATTO DOCCIA
IN CERAMICA
H 5,5 CM

PIATTO DOCCIA ITO H 5,5 CM

CERAMICA BIANCO LUCIDO / GLOSS WHITE CERAMIC

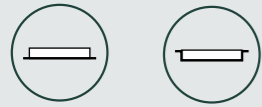

cm 72x90

○ COD. 40248



cm 70x100

○ COD. 40397



cm 70x120

○ COD. 40398



cm 70x140

○ COD. 40328



cm 80x80

○ COD. 40249



cm 80x100

○ COD. 40399



cm 80x120

○ COD. 40400



cm 80x140

○ COD. 40401



cm 90x90

○ COD. 40250



PIATTO DOCCIA ITO H 5,5 CM

CERAMICA BIANCO LUCIDO / GLOSS WHITE CERAMIC

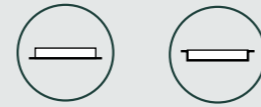

cm 72x90 DX

○ COD. 40827



cm 72x90 SX

○ COD. 40832



cm 80x80 A

○ COD. 40251



cm 90x90 A

○ COD. 40402



PIATTO DOCCIA ITO H 5,5 CM



DISPONIBILE COPERCHIO
CROMATO O IN CERAMICA
AVAILABLE WITH CHROMED
OR CERAMIC COVER



TEXTURE ANTISCIVOLO
ANTI-SLIP TEXTURE



CERAMICA BIANCO LUCIDO
FINE FIRE CLAY
FINE FIRE CLAY
GLOSS WHITE CERAMIC

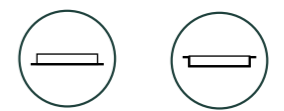

INSTALLAZIONE PAVIMENTO
O FILOPAVIMENTO
FLOOR OR LEVEL ACCESS
INSTALLATION



ITO
CM 140X80



BIANCO
LUCIDO

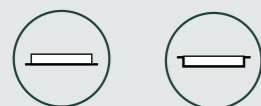
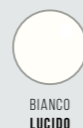
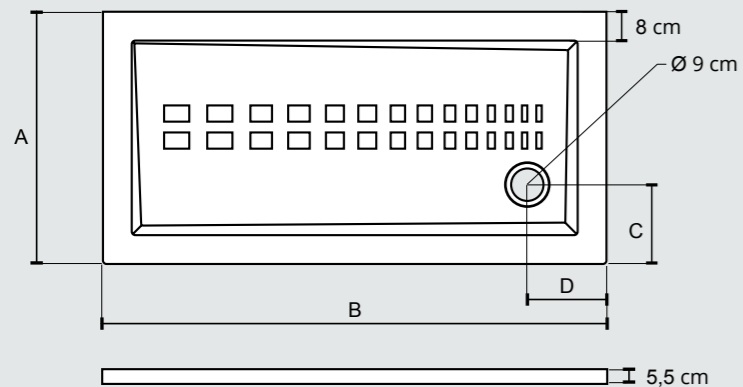

CONSIGLIATO ABBINAMENTO CON:

SUGGESTED COMBINATION WITH:

Scarico sifonato ed ispezionabile
Siphoned and inspectable drain



Coperchio in ABS cromato
Chromed ABS cover
cod. **SCPD90**



Coperchio in ceramica - BIANCO LUCIDO
Ceramic cover - GLOSS WHITE
cod. **SCPD90C#BL**

***LATO NON SMALTATO**

*UNGLAZED SIDE

ITO 70

| COD. | cm A X B | cm C | cm D | KG |
|-------|-----------|-------|-------|----|
| 40248 | cm 72X90 | cm 22 | cm 22 | 26 |
| 40397 | cm 70X100 | cm 22 | cm 22 | 29 |
| 40398 | cm 70X120 | cm 22 | cm 22 | 34 |
| 40328 | cm 70X140 | cm 22 | cm 22 | 38 |

ITO 80

| COD. | cm A X B | cm C | cm D | KG |
|-------|-----------|-------|-------|----|
| 40249 | cm 80X80 | cm 22 | cm 22 | 26 |
| 40399 | cm 80X100 | cm 22 | cm 22 | 32 |
| 40400 | cm 80X120 | cm 22 | cm 22 | 39 |
| 40401 | cm 80X140 | cm 22 | cm 22 | 43 |

ITO 90

| COD. | cm A X B | cm C | cm D | KG |
|-------|----------|-------|-------|----|
| 40250 | cm 90X90 | cm 22 | cm 22 | 33 |

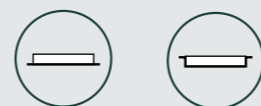
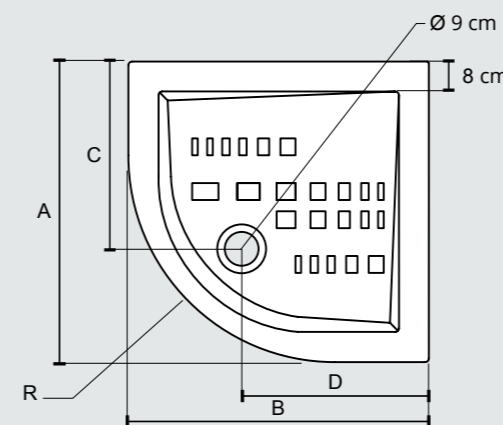

CONSIGLIATO ABBINAMENTO CON:

SUGGESTED COMBINATION WITH:

Scarico sifonato ed ispezionabile
Siphoned and inspectable drain



Coperchio in ABS cromato
Chromed ABS cover
cod. **SCPD90**



Coperchio in ceramica - BIANCO LUCIDO
Ceramic cover - GLOSS WHITE
cod. **SCPD90C#BL**

***LATO NON SMALTATO**

*UNGLAZED SIDE

ITO ANGOLARE / QUAD

| COD. | cm A X B | cm C | cm D | cm R | KG |
|-------|----------|---------|---------|-------|----|
| 40251 | cm 80X80 | cm 49,8 | cm 49,8 | cm 55 | 23 |
| 40402 | cm 90X90 | cm 59,7 | cm 59,7 | cm 55 | 29 |

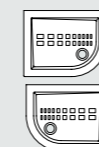

| COD. | cm A X B | cm C | cm D | cm R | KG |
|-------|-------------|-------|-------|-------|----|
| 40827 | cm 72X90 DX | cm 47 | cm 65 | cm 38 | 24 |
| 40832 | cm 72X90 SX | cm 47 | cm 65 | cm 38 | 24 |

PIATTO DOCCIA LONDON H 2,5 CM

LONDON

PIATTO DOCCIA
H 2,5 CM
EFFETTO PIETRA

LONDON CM 120X80



BIANCO
WHITE
#B0

SPESSORE PIENO PIGMENTATO **IN MASSA**
FULL-PIGMENTED THICKNESS



GAMMA COMPLETA
DI MISURE E FORMATI
WIDE RANGE OF FORMATS
AND SIZES

EFFETTO PIETRA
STONE EFFECT
TEXTURE ANTISCIVOLO
ANTI-SLIP TEXTURE



REVERSIBILITÀ DI MONTAGGIO
REVERSIBLE

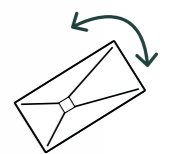

TAGLIABILE A MISURA
CUT TO SIZE



INSTALLAZIONE PAVIMENTO O FILOPAVIMENTO
FLOOR OR LEVEL ACCESS INSTALLATION





INCLUSA GRIGLIA DI DEFLUSSO IN ACCIAIO INOX
STAINLESS STEEL FLOW GRID INCLUDED

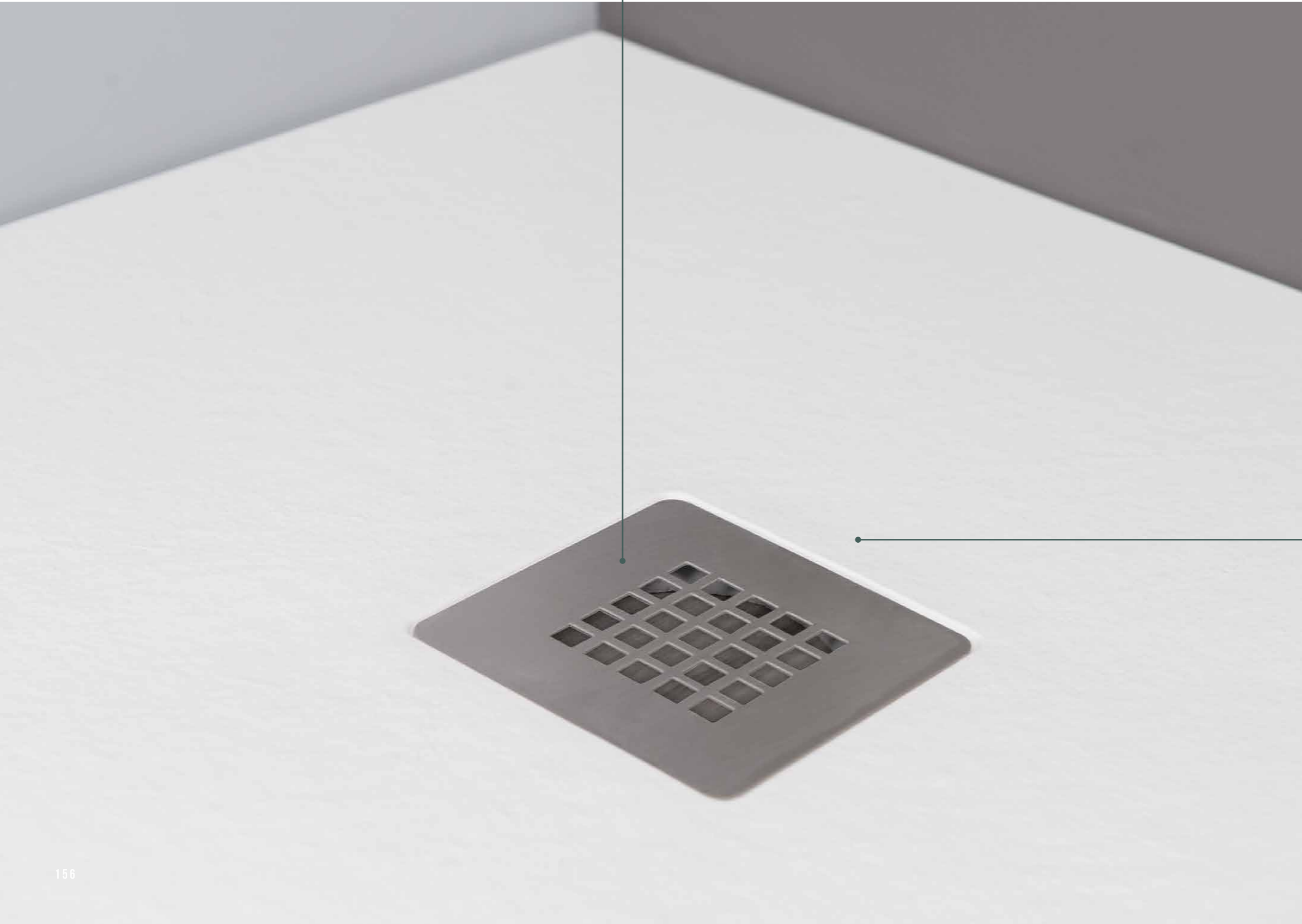

SCARICO SIFONATO ED ISPEZIONABILE 90 MM
SIPHONED AND INSPECTABLE DRAIN 90 MM



LONDON CM 80X80



LONDON
ANGOLARE / QUAD
CM 90X90

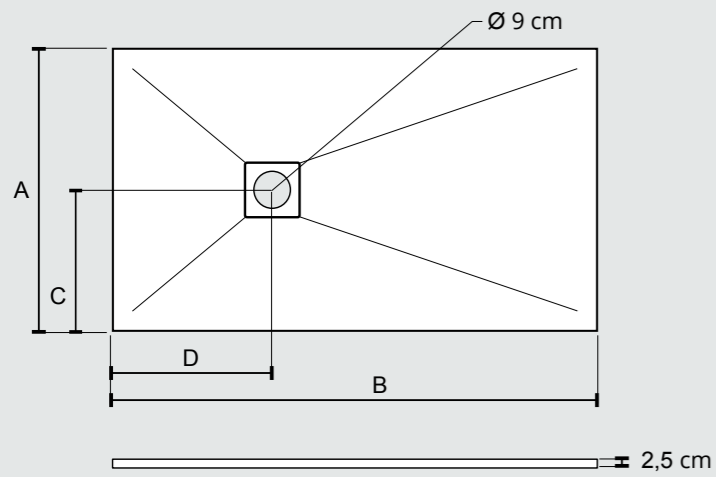

BIANCO
WHITE
#B0

CONSIGLIATO ABBINAMENTO CON:
SUGGESTED COMBINATION WITH:



Scarico sifonato ed ispezionabile
Siphoned and inspectable drain

cod. SPD90

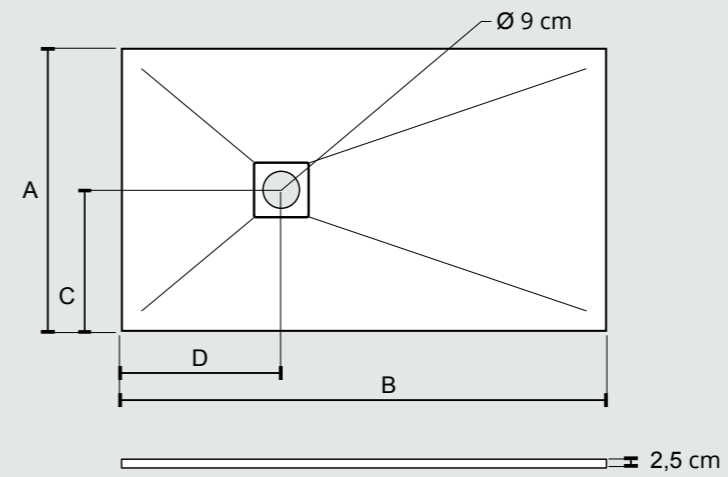

BIANCO
WHITE
#B0

CONSIGLIATO ABBINAMENTO CON:
SUGGESTED COMBINATION WITH:



Scarico sifonato ed ispezionabile
Siphoned and inspectable drain

cod. SPD90



LONDON 70

| COD. | cm A X B | cm C | cm D | KG |
|-------|-----------|-------|-------|----|
| LN79 | cm 70X90 | cm 35 | cm 35 | 27 |
| LN710 | cm 70X100 | cm 35 | cm 35 | 30 |
| LN712 | cm 70X120 | cm 35 | cm 45 | 39 |
| LN714 | cm 70X140 | cm 35 | cm 45 | 46 |
| LN715 | cm 70X150 | cm 35 | cm 45 | 50 |
| LN716 | cm 70X160 | cm 35 | cm 55 | 55 |
| LN717 | cm 70X170 | cm 35 | cm 55 | 63 |
| LN718 | cm 70X180 | cm 35 | cm 55 | 72 |

LONDON 80

| COD. | cm A X B | cm C | cm D | KG |
|-------|-----------|-------|-------|----|
| LN88 | cm 80X80 | cm 40 | cm 40 | 27 |
| LN810 | cm 80X100 | cm 40 | cm 35 | 32 |
| LN812 | cm 80X120 | cm 40 | cm 45 | 41 |
| LN814 | cm 80X140 | cm 40 | cm 45 | 48 |
| LN815 | cm 80X150 | cm 40 | cm 45 | 52 |
| LN816 | cm 80X160 | cm 40 | cm 55 | 57 |
| LN817 | cm 80X170 | cm 40 | cm 55 | 65 |
| LN818 | cm 80X180 | cm 40 | cm 55 | 74 |

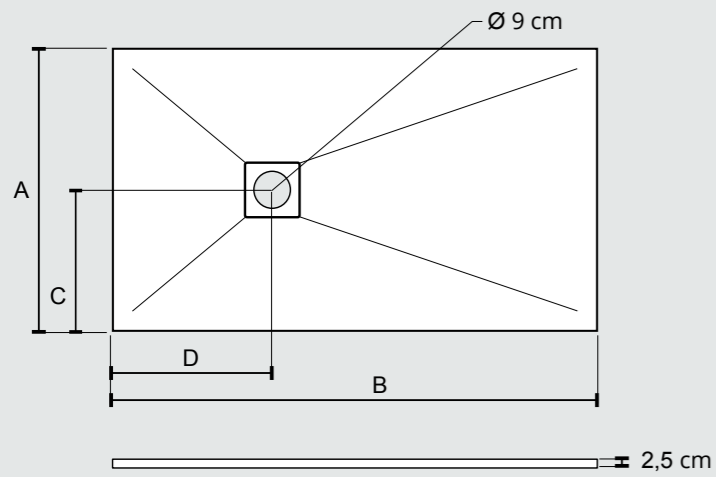

BIANCO
WHITE
#B0

CONSIGLIATO ABBINAMENTO CON:
SUGGESTED COMBINATION WITH:



Scarico sifonato ed ispezionabile
Siphoned and inspectable drain

cod. SPD90



LONDON 90

| COD. | cm A X B | cm C | cm D | KG |
|-------|-----------|-------|-------|----|
| LN99 | cm 90X90 | cm 45 | cm 45 | 32 |
| LN910 | cm 90X100 | cm 45 | cm 35 | 34 |
| LN912 | cm 90X120 | cm 45 | cm 45 | 43 |
| LN914 | cm 90X140 | cm 45 | cm 45 | 50 |
| LN915 | cm 90X150 | cm 45 | cm 45 | 54 |
| LN916 | cm 90X160 | cm 45 | cm 55 | 59 |
| LN917 | cm 90X170 | cm 45 | cm 55 | 68 |
| LN918 | cm 90X180 | cm 45 | cm 55 | 78 |

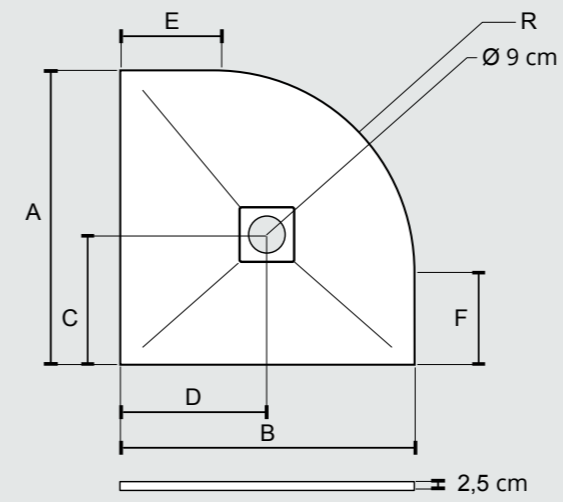

BIANCO
WHITE
#B0

CONSIGLIATO ABBINAMENTO CON:
SUGGESTED COMBINATION WITH:



Scarico sifonato ed ispezionabile
Siphoned and inspectable drain

cod. SPD90



LONDON ANGOLARE / QUAD

| COD. | cm A X B | cm C | cm D | cm E | cm F | cm R | KG |
|------|----------|-------|-------|-------|-------|-------|----|
| LN8A | cm 80X80 | cm 40 | cm 40 | cm 25 | cm 20 | cm 55 | 25 |
| LN9A | cm 90X90 | cm 45 | cm 45 | cm 35 | cm 31 | cm 55 | 30 |



TAGLIO SU MISURA

Grazie alla loro pregiata composizione di minerali naturali e resine, i piatti doccia in **EFFETTO PIETRA** sono riducibili e tagliabili su misura così da soddisfare tutte le esigenze, adattandosi alle particolari conformazioni di ogni ambiente bagno.

Thanks to their high quality composition of natural minerals and resins, the shower trays in **STONE EFFECT** can be reduced and cut to size in order to satisfy all needs, fitting each particular bathroom conformation.



EFFETTO PIETRA - STONE EFFECT

INFINITE POSSIBILITÀ DI TAGLIO SU MISURA / ENDLESS POSSIBILITIES OF CUSTOM CUTS

□ TIPOLOGIA TAGLIO A

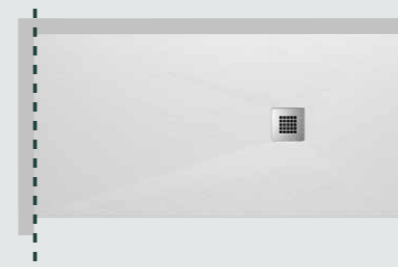

□ TIPOLOGIA TAGLIO B

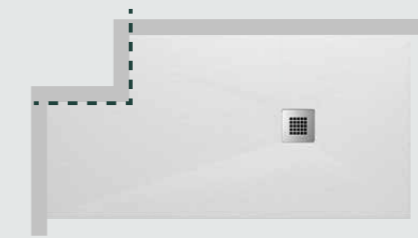

□ TIPOLOGIA TAGLIO C

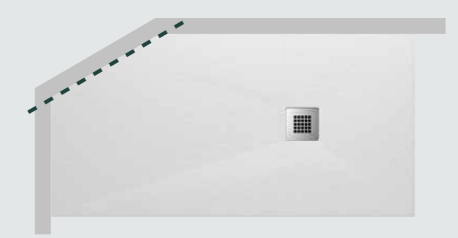

□ TIPOLOGIA TAGLIO D

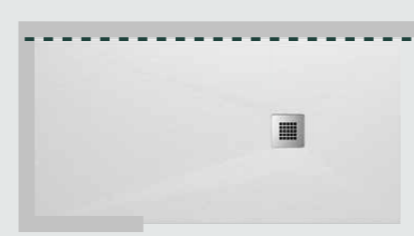

□ TIPOLOGIA TAGLIO E

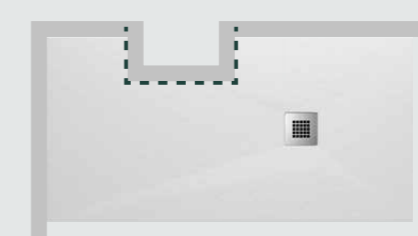

□ TIPOLOGIA TAGLIO F



TAGLI SU MISURA EFFETTUATI SUL LUOGO D'INSTALLAZIONE CUSTOM CUTS MADE ON THE INSTALLATION SITE

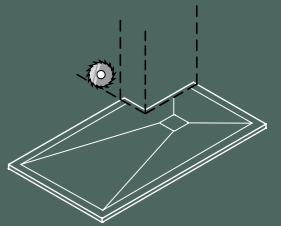

- Misurare l'area disponibile per l'installazione del piatto doccia.
1. Measure the area available for installing the shower tray.
- Disegnare la dima del piatto doccia su di un cartoncino da ritagliare sulla base della forma finale del piatto doccia.
2. Draw the shower tray template on cardboard to be cut out based on the final shape of the shower tray.
- Sovrapporre il cartoncino sulla parte inferiore del piatto doccia.
3. Place the cardboard over the underside of the shower tray.
- Tracciare il segno che sarà utile da guida per il taglio del piatto doccia.
4. Trace the sign that will be useful as a guide for cutting the shower tray.
- Fissare il piatto doccia al piano di lavoro.
5. Fix the shower tray to the work surface.
- Utilizzare una sega radiale con disco diamantato per effettuare le lavorazioni necessarie. E' fondamentale non arrestare mai la sega radiale durante le operazioni di taglio netto, così da evitare scheggiature superficiali.
6. Use a radial saw with a diamond disc to carry out the necessary work. It is essential never to stop the radial saw during the net cutting operations, so as to avoid superficial chippings.
- Il lato tagliato dovrà essere installato in corrispondenza di una parete o di un pilastro.
7. The cut side must be installed in correspondence to a wall or a pillar.

MATERIALE PROMOZIONALE / PROMOTIONAL MATERIAL

Espositore metallico per WC e bidet sospesi
Metal display stand for wall hung wc and bidet

COD. **MINIEXPO**

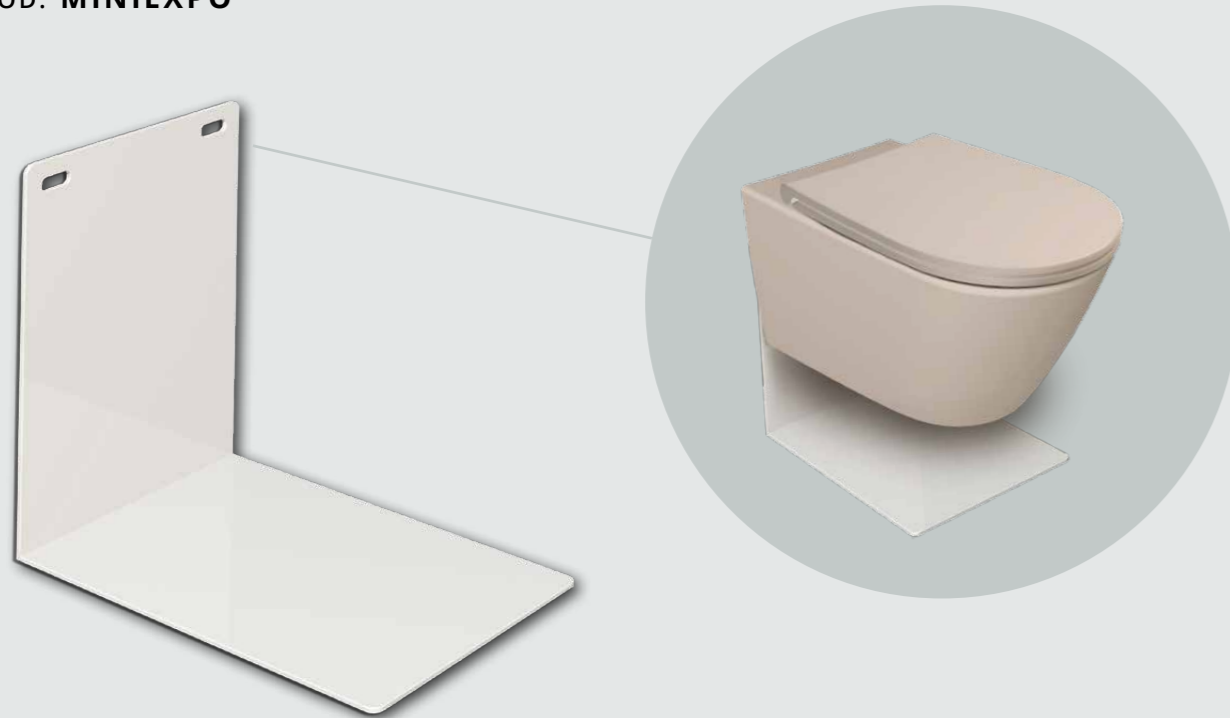

Campionario finiture Plus+ton
Plus+ton colour samples

COD. **CAMPPL**



MATERIALE PROMOZIONALE / PROMOTIONAL MATERIAL

Espositore in legno piatto doccia
Wooden display for shower tray

COD. **ESPOSITORE2**

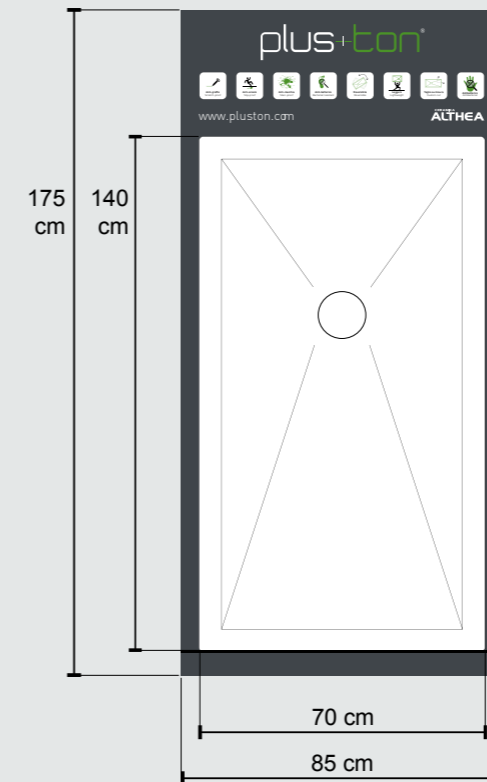

> Su richiesta sarà possibile abbinare all'espositore i seguenti piatti doccia:

LONDON e CITY cm 140x70 - BIT 140x80

> Upon request, it will be possible to combine the shower tray display stand with the following shower trays:
cm 140x70 LONDON and CITY - BIT 140x80

Memoria USB con contenuti multimediali
USB memory with multimedia contents



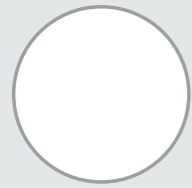

BIANCO
LUCIDO

plus+ton® COLOURS

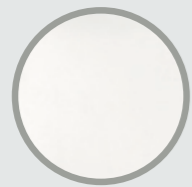

BIANCO
OPACO
#01



LINO
OPACO
#02



CEMENTO
OPACO
#03

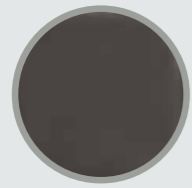

FERRO
OPACO
#05



BEIGE
OPACO
#06

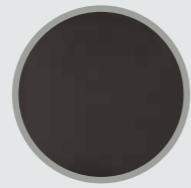

NERO
OPACO
#09

EFFETTO PIETRA / STONE EFFECT



BIANCO
WHITE
#B0

CONDIZIONI DI VENDITA

🇮🇹 CONDIZIONI GENERALI DI VENDITA

ORDINI:

dovranno essere passati alla società e dalla stessa confermati, sia per i prezzi sia per il termine di consegna. La merce è venduta franco fabbrica e viaggio, in ogni caso, a rischio e pericolo del committente.

TRASPORTO:

rimane sempre a carico del committente per conto del quale la società esegue la spedizione.

PREZZI:

la società si riserva la facoltà di variare i prezzi senza alcun preavviso. In ogni caso i prezzi validi saranno quelli del listino in vigore al momento della consegna. Tutti i prezzi si intendono esclusi IVA.

PAGAMENTI:

i pagamenti debbono essere effettuati, esclusivamente, presso la sede della società fornitrice, salvo patto contrario espresso. Il mancato pagamento di una eventuale precedente fornitura autorizza la Società Ceramica Althea Spa a sospendere le forniture e ad annullare eventuali ordini in portafoglio. In caso di contestazione di qualsiasi natura il committente non ha diritto di sospendere i pagamenti.

CONSEGNA:

i termini di consegna sono puramente indicativi. In ordine a tali termini, pertanto, la Società fornitrice non potrà assumere responsabilità di qualsiasi genere, salvo i casi di pattuizione espressa.

PESI E MISURE:

entrambi sono approssimativi e pertanto la Società fornitrice non potrà assumere alcun tipo di responsabilità per gli stessi.

RECLAMI:

dovranno pervenire alla ns. Sede non oltre otto giorni dal ricevimento della merce. In ogni caso non si accettano merci di ritorno, senza che sia intercorso un accordo in tal senso con la fornitrice. L'installazione del prodotto sarà considerata come accettazione della sua qualità.

RISERVA DI PROPRIETA':

fino a che il pagamento non sia stato completato la merce rimane di proprietà della fornitrice.

DATI RIGUARDANTI IL COMMITTENTE:

il committente è responsabile di tutti i dati identificativi, in particolare, per quanto si riferisce alle norme relative all'anagrafe tributaria (Codice Fiscale).

DOMICILIO LEGALE:

per qualsiasi controversia, competente è il Foro di Viterbo (Italia).

INTERESSI MORATORI:

qualora si verificassero ritardi dei pagamenti verranno addebitati gli interessi al tasso praticato dagli Istituti di Credito all'atto dell'addebito.

DIMENSIONI:

le misure di ciascun lavabo sono da considerarsi identificative e suscettibili di variazioni a causa delle caratteristiche peculiari della lavorazione ceramica.

Ceramica Althea Spa si riserva il diritto di apportare, in qualsiasi momento, modifiche tecniche, costruttive e dimensionali utili al miglioramento della produzione.

Le tonalità degli smalti possono subire lievi variazioni da considerarsi in tolleranza a causa delle caratteristiche peculiari della lavorazione ceramica.

L'azienda si riserva il diritto di apportare modifiche o rimuovere dalla produzione gli articoli presenti in questo catalogo senza preavviso.

🇬🇧 GENERAL SALE TERMS

ORDERS:

must be placed with the firm that will confirm both prices and delivery terms. Goods are sold on an ex-factory basis and transport is carried out at the customer's own risk.

TRANSPORT:

is always to be paid by the customer on whose behalf the firm may ship the goods.

PRICES:

the firm reserves the right to vary prices without any previous notice. In any case, the prices to be considered valid are those contained in the price-list in force at the time of delivery.

Prices do not include V.A.T.

PAYMENT:

must be made exclusively to the supplying firm unless otherwise agreed upon. Failure to pay a previous supply allows the firm Ceramica Althea Spa to stop shipping goods and cancel any pending order. In case of any claims, the customer must not suspend payment.

DELIVERY:

dates are merely approximate. Consequently the supplying firm bears no responsibility for delivery dates, unless otherwise agreed upon.

WEIGHT AND SIZES:

these are approximate and therefore the firm bears no responsibility for them.

CLAIMS:

must be submitted to our head office within 8 days upon receipt of the goods. Returned goods are not accepted unless otherwise agreed upon with the manufacturer.

Installation of the product will be taken as acceptance of its quality.

RIGHTS OF OWNERSHIP:

until payment is fully settled, the goods remain the property of the supplying firm.

CUSTOMER DETAILS:

the customer is responsible for all identification details provided, particularly for those referring to the tax register office (tax code).

LEGAL RESIDENCE:

for any controversy the competent court is the Court of Viterbo (Italy).

INTEREST ON DELAYED PAYMENTS:

should there be delay in payments, interest will be charged at the rate fixed by credit institutions at the moment of debiting.

DIMENSIONS:

the measures of each basin are to be considered as approximate and susceptible to variations because of the specific characteristics of the ceramic workmanship.

Ceramica Althea Spa reserves the right to make, at any moment, technical, constructive and dimensional changes useful to improve the production.

The shades of the glaze may undergo slight variations that are to be considered within the accepted tolerance due to the peculiar characteristics of the ceramic production. The company reserves the right to change or remove from production the items in this catalogue without prior notice.

NOTE



Ceramica Althea S.p.A.

Viale delle Industrie, 9
01033 - Civita Castellana - VT - Italy
tel. +39 0761.542144 - fax +39 0761.540242
info@altheaceramica.it
www.altheaceramica.it - www.pluston.com

Design - Althea Design

© Copyright Ceramica Althea S.p.A. - Aprile 2023

CERAMICA
ALTHEA